



# Custom Craft Distribution, Inc.

RAILING • FENCING • PERGOLAS

## 2025 PRICE BOOK

MULTIPLIER

SHADED ITEMS IN PRICE BOOK ARE NON-STOCK



# TERMS AND CONDITIONS



Custom Craft<sup>™</sup>  
Distribution, Inc.

## ORDERS

All orders are subject to acceptance by Custom Craft Distribution, Inc. (Custom Craft) and should be emailed to [support@customcrafdist.com](mailto:support@customcrafdist.com). An order acknowledgment will typically be emailed within one (1) business day and list estimated ship date. Every effort will be made to meet this estimated ship date but it is not a guarantee. Errors or omissions within the acknowledgement are the responsibility of the customer. All fencing is made to order and is subject to lead times in effect at the time of order.

## SHIPPING

Refer to *Freight Schedule* for standard shipping charges, if any. Most stocked items ship freight included. Any applicable shipping charges will be shown on order acknowledgment.

## DAMAGES AND SHORTAGES

Please immediately inspect all product received for damage or shortage. Any visible damage or shortage must be noted on bill of lading and pictures taken to document damage. Report damages or shortage, including hidden damage, to Custom Craft within two (2) business days of delivery.

## RETURNS

All returns require an RMA number from Custom Craft. **Stock items may be returned within 90 days from purchase date if they are unopened, undamaged, and in resalable condition.** Fencing, glass panels/pickets, non-stock, made to order, discontinued or special order items may not be returned. Parts and pieces may not be returned. Credit will be given at the invoice price less a 25% restocking fee. All return shipping charges are the responsibility of the customer. Credit will NOT be issued for any opened, used, damaged products, or for any kit parts and pieces. Items not meeting requirements above and returned to Custom Craft will be disposed of at Custom Craft's discretion and no credit will be given.

## TERMS AND CREDIT

Past due accounts may incur a service charge according to the terms and conditions of your account. Customer credit approval is required prior to order processing. Failure to maintain account in good standing will result in the suspension or revocation of credit.

## PRICES AND AVAILABILITY

Prices and availability are subject to change without notice. The possession of this catalog by any firm or individual should not be considered an offer to sell the products listed or at the prices specified herein.

## DISCLAIMER OF WARRANTIES

The written warranty of the manufacturer of any product described herein will be assigned to the buyer. Custom Craft is not responsible for the manufacturer's compliance with any or all of the terms of their warranty.

# FREIGHT SCHEDULE



Custom Craft<sup>™</sup>  
Distribution, Inc.

## **ZONE 1**

All STOCKED railing and accessories will ship freight included EXCEPT:

- Orders of \$300 or less will incur a handling charge of \$15.00
- Items over 9' or a length plus girth of 130" or greater may incur a \$100.00 handling charge per item.
- Items 10' to 12' in length may be subject to special handling/pallet charges.
- Items over 12' must be picked up by the customer.
- All orders with glass will have freight added to invoice
- All NON-STOCK, SPECIAL ORDER, MADE-TO-ORDER, FENCING, PERGOLAS, ETC. items are subject to freight charges. All shaded items in Price Book are considered non-stock or special order.
- ANY FREIGHT CHARGES WILL BE SHOWN ON ORDER ACKNOWLEDGMENT

### **Zone 1 Shipping Area:**

Illinois (ZIP CODES 600-605, 607-620, 622-629)

Iowa

Minnesota

Missouri (ZIP CODES 630-631, 633)

Nebraska (DELIVERY TO CERTAIN ZIP CODES RESTRICTED - CONTACT CUSTOM CRAFT FOR DETAILS)

North Dakota (DELIVERY TO CERTAIN ZIP CODES RESTRICTED - CONTACT CUSTOM CRAFT FOR DETAILS)

South Dakota (DELIVERY TO CERTAIN ZIP CODES RESTRICTED - CONTACT CUSTOM CRAFT FOR DETAILS)

Wisconsin (FERRY CHARGES APPLY TO 54246, 54850)

## **ZONE 2**

All areas not listed in Zone 1 above will be shipped FOB Shipping Point and freight added.



# **ADVANTAGE ALUMINUM RAILING**

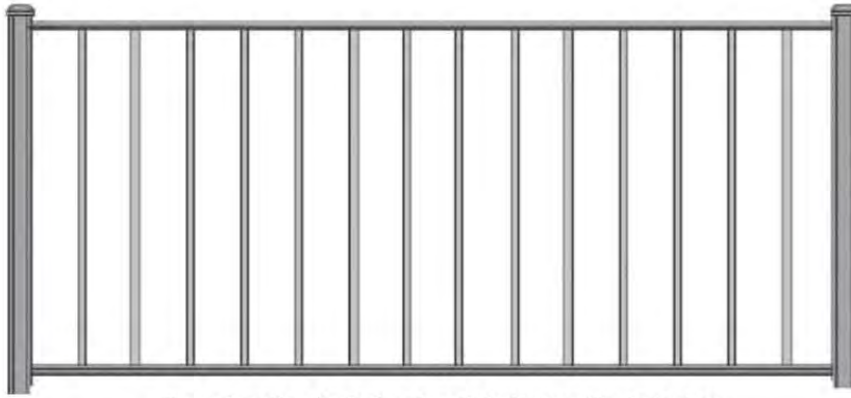

*Boxed section includes: top & bottom rails, balusters, mounting brackets w/ screws, section support, and installation guide. Post, caps and trim sold separately.*



**TOP  
RAIL**



**BOTTOM  
RAIL**



#15428 & #15433  
Post Kit (Post, Cap & Trim)



#15610  
Level Bracket



#15613  
Stair Bracket



#15630  
Drink Rail Bracket Kit



#15616  
Universal Swivel Bracket



#15800 & #15802  
Drink Rail Adapter

COLORS: Textured Black (TBL), Textured Bronze (TBZ), Textured White (TWH) **\*\*Two Tone Railing Available - Add 18%\*\***

ITEM #	ALUMINUM RAILING LEVEL KITS	TBL	TBZ	TWH
15100	Advantage Level Rail Kit - 36"x5'	239.69	239.69	239.69
15103	Advantage Level Rail Kit - 36"x6'	279.35	279.35	279.35
15106	Advantage Level Rail Kit - 36"x7'	324.86	324.86	324.86
15109	Advantage Level Rail Kit - 36"x8'	359.01	359.01	359.01
15133	Advantage Level Rail Kit - 42"x6'	307.28	334.41	334.41
ITEM #	ALUMINUM RAILING STAIR KITS	TBL	TBZ	TWH
15115	Advantage Stair Rail Kit - 36"x6'	279.35	279.35	279.35
15118	Advantage Stair Rail Kit - 36"x8'	359.01	359.01	359.01



# ADVANTAGE SQUARE BALUSTER RAILING

2025 Price Book

ITEM #	POSTS & ACCESSORIES	TBL	TBZ	TWH
15428	Advantage 2½"x38" Residential Post Kit With Cap and Trim	105.84	105.84	105.84
15433	Advantage 2½"x44" Residential Post Kit With Cap and Trim	112.35	112.35	112.35
15449	Advantage 3½"x38" Heavy Wall Post Kit With Cap and Trim	167.35	167.35	167.35
15452	Advantage 3½"x44" Heavy Wall Post Kit With Cap and Trim	181.93	181.93	181.93
15454	Structural Post 3½"x108" (w/ Mounting Brackets)	306.00	306.00	306.00
15455	Structural Post 3½"x120" (w/ Mounting Brackets) - OVERSIZED	306.00	306.00	306.00
15470	Post - No Plate - 2½"x50" (Available Spring 2025)	91.97	91.97	91.97
15827	Fascia Mount Bracket - Line - 2½" (Available Spring 2025)	79.85	79.85	79.85
15828	Fascia Mount Bracket - Corner - 2½" (Available Spring 2025)	101.74	101.74	101.74
15478	Post Wrap - 4 Piece - 6"x108"	338.22	338.22	338.22
15480	Post Wrap - 4 Piece - 6"x120" - OVERSIZED	338.22	338.22	338.22
15710	Post Cap - Flat - 2½"	9.37	9.37	9.37
15713	Post Cap - Flat - 3½"	12.71	12.71	12.71
15750	Post Trim - 2½"	16.78	16.78	16.78
15753	Post Trim - 3½"	27.51	27.51	27.51
15770	Post Trim - 6" - 2 Piece	60.83	60.83	60.83
39410	Concrete - GRK Post Screw - 19/64" x 3½" - Bag of 24	51.25	-	-
39430	Wood - GRK Post Screw - 5/16" x 4" - Box of 25	26.41	-	-
39433	Wood - GRK Post Screw - 5/16" x 4" - Box of 100	88.03	-	-
39436	Wood - GRK Post Screw - 5/16" x 4" - Box of 400	294.07	-	-
ITEM #	ACCESSORIES	TBL	TBZ	TWH
15610	Advantage Rail Bracket Pack - Level - 4 pc	52.89	52.89	52.89
15613	Advantage Rail Bracket Pack - Stair - 4 pc	60.30	60.30	60.30
15616	Advantage Universal Swivel Rail Bracket Pack - 4 pc	101.07	101.07	101.07
15630	Advantage Drink Rail Bracket Pack - Level - 2 pc	31.39	31.39	31.39
39315	Deck Board Railing Connector	30.41	-	-
15800	Advantage Drink Rail Adapter - 6'	80.86	80.86	80.86
15802	Advantage Drink Rail Adapter - 8'	98.83	98.83	98.83
15820	Advantage Rail - Foot Block	8.33	8.33	8.33
15823	Advantage Cross Over Bracket Adapter - 2½"	123.36	123.36	123.36
15830	Advantage Touch Up Paint - 4.5oz	24.97	24.97	24.97
ITEM #	GATES & HARDWARE	TBL	TBZ	TWH
15350	Advantage Gate Kit - 36"x48"	401.80	401.80	401.80
17751	Self Closing Gate Hinge Set	58.55	-	58.55
17752	Gate Latch	50.25	-	50.25

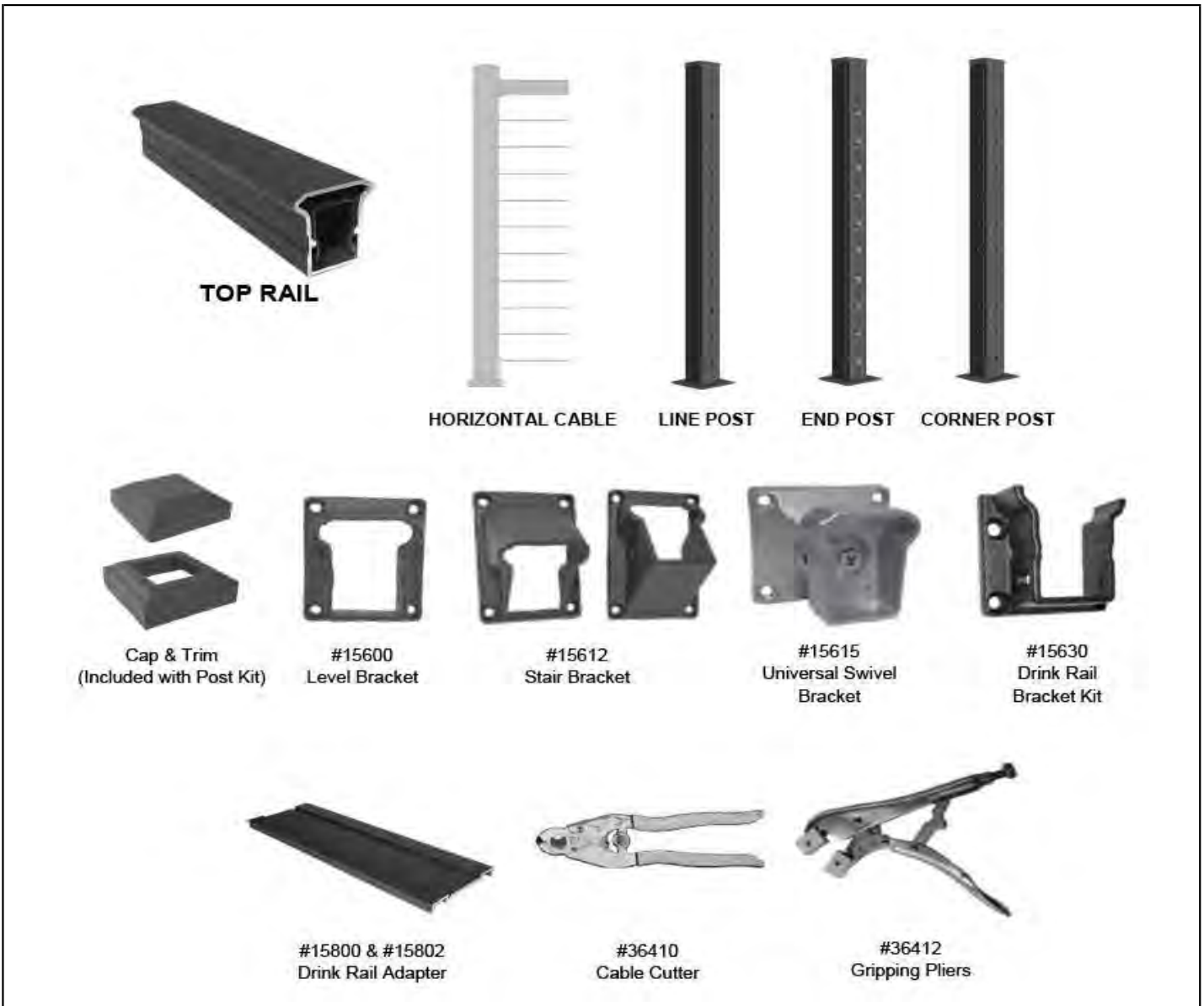

COLORS: Textured Black (TBL), Textured Bronze (TBZ), Textured White (TWH)

ITEM #	ALUMINUM RAILING LEVEL KITS	TBL	TBZ	TWH
15210	Advantage - Horizontal Cable - Level Rail Kit - 36"x6'	128.51	128.51	128.51
15213	Advantage - Horizontal Cable - Level Rail Kit - 36"x8'	167.81	167.81	167.81
ITEM #	ALUMINUM RAILING STAIR KITS	TBL	TBZ	TWH
15218	Advantage - Horizontal Cable - Stair Rail Kit - 36"x6'	128.51	128.51	128.51
15221	Advantage - Horizontal Cable - Stair Rail Kit - 36"x8'	167.81	167.81	167.81
ITEM #	POSTS & ACCESSORIES	TBL	TBZ	TWH
15510	JAM - Cable Level End Post Kit (w/Cap & Trim) - 2½"x38"	637.12	637.12	637.12
15511	JAM - Cable Level Corner Post Kit (w/Cap & Trim) - 2½"x38"	154.97	154.97	154.97
15512	JAM - Cable Level Line Post Kit (w/Cap & Trim) - 2½"x38"	154.97	154.97	154.97
15515	JAM - Cable Stair End Post Kit (w/Cap & Trim) - 2½"x41"	637.12	637.12	637.12
15516	JAM - Cable Stair Line Post Kit (w/Cap & Trim) - 2½"x41"	154.97	154.97	154.97
39410	Concrete - GRK Post Screw - 19/64" x 3½" - Bag of 24	51.25	-	-
39430	Wood - GRK Post Screw - 5/16" x 4" - Box of 25	26.41	-	-
39433	Wood - GRK Post Screw - 5/16" x 4" - Box of 100	88.03	-	-
39436	Wood - GRK Post Screw - 5/16" x 4" - Box of 400	294.07	-	-





# ADVANTAGE HORIZONTAL CABLE RAILING

2025 Price Book

ITEM #	ACCESSORIES	TBL	TBZ	TWH
15600	Advantage - Level Brackets - 2 Pk	31.39	31.39	31.39
15612	Advantage - Stair Brackets - 2 Pk	42.06	42.06	42.06
15615	Advantage - Universal Swivel Brackets - 2 Pk	61.85	61.85	61.85
15630	Advantage Drink Rail Bracket Pack - Level - 2 pc	31.39	31.39	31.39
39315	Deck Board Railing Connector	30.41	-	-
15800	Advantage Drink Rail Adapter - 6'	80.86	80.86	80.86
15802	Advantage Drink Rail Adapter - 8'	98.83	98.83	98.83
15823	Advantage Cross Over Bracket Adapter - 2½"	123.36	123.36	123.36
15830	Advantage Touch Up Paint - 4.5oz	24.97	24.97	24.97
ITEM #	GATES & HARDWARE	TBL	TBZ	TWH
15370	Advantage - Horizontal Cable Gate - 36"x48' - REQUIRES CABLE	1,388.22	1,388.22	1,388.22
17751	Self Closing Gate Hinge Set	58.55	-	58.55
17752	Gate Latch	50.25	-	50.25
ITEM #	CABLE & TOOLS	N/A	TBZ	TWH
18470	Cable Roll (1/8") - 100 FT	105.04	-	-
18471	Cable Roll (1/8") - 250 FT	234.12	-	-
18471-B	(NS) Cable Roll (1/8") - 250 FT - Black	841.08		
18472	Cable Roll (1/8") - 500 FT	433.33	-	-
36410	Felco C7 Cable Cutter	105.40	-	-
36412	Cable Gripping Pliers	61.48	-	-
36420	Loos PT-1 Cable Tension Gauge	205.79	-	-
36422	Advantage Cable Installation Kit	63.87	-	-
36430	Cable Threading Needle	7.02	-	-
36431	Cable Corner Threading Needle	29.10	-	-
36432	3/16" Cable Allen Wrench	1.69	-	-
36441	Cable Rust & Corrosion Protection Boeshield T-9 (4 oz.)	23.71	-	-
36450	Advantage Cable Tensioner Fitting (Stud & Jaw Only) - 2 Pack	20.21	-	-



**TOP RAIL**



#15428 & #15433  
Post Kit (Post, Cap & Trim)



#15610  
Level Bracket



#15613  
Stair Bracket



#15616  
Universal Swivel Bracket



#15630  
Drink Rail Bracket Kit



#15800 & #15802  
Drink Rail Adapter

COLORS: Textured Black (TBL), Textured Bronze (TBZ), Textured White (TWH) - Available Spring 2025

ITEM #	ALUMINUM RAILING LEVEL KITS	TBL	TBZ	TWH
15165	Advantage VertiRod - Level Rail Kit - 36"x6'	435.21	435.21	435.21
15167	Advantage VertiRod - Level Rail Kit - 36"x8'	573.28	573.28	573.28
ITEM #	ALUMINUM RAILING STAIR KITS	TBL	TBZ	TWH
15170	Advantage VertiRod - Stair Rail Kit - 36"x6'	435.21	435.21	435.21
15172	Advantage VertiRod - Stair Rail Kit - 36"x8'	573.28	573.28	573.28
ITEM #	POSTS & ACCESSORIES	TBL	TBZ	TWH
15428	Advantage 2½"x38" Residential Post Kit With Cap and Trim	105.84	105.84	105.84
15433	Advantage 2½"x44" Residential Post Kit With Cap and Trim	112.35	112.35	112.35



# ADVANTAGE VERTIROD

2025 Price Book

15449	Advantage 3½"x38" Heavy Wall Post Kit With Cap and Trim	167.35	167.35	167.35
15452	Advantage 3½"x44" Heavy Wall Post Kit With Cap and Trim	181.93	181.93	181.93
15454	Structural Post 3½"x108" (w/ Mounting Brackets)	306.00	306.00	306.00
15455	Structural Post 3½"x120" (w/ Mounting Brackets) - OVERSIZED	306.00	306.00	306.00
15470	Post - No Plate - 2½"x50" (Available Spring 2025)	91.97	91.97	91.97
15827	Fascia Mount Bracket - Line - 2½" (Available Spring 2025)	79.85	79.85	79.85
15828	Fascia Mount Bracket - Corner - 2½" (Available Spring 2025)	101.74	101.74	101.74
15478	Post Wrap - 4 Piece - 6"x108"	338.22	338.22	338.22
15480	Post Wrap - 4 Piece - 6"x120" - OVERSIZED	338.22	338.22	338.22
15710	Post Cap - Flat - 2½"	9.37	9.37	9.37
15713	Post Cap - Flat - 3½"	12.71	12.71	12.71
15750	Post Trim - 2½"	16.78	16.78	16.78
15753	Post Trim - 3½"	27.51	27.51	27.51
15770	Post Trim - 6" - 2 Piece	60.83	60.83	60.83
39410	Concrete - GRK Post Screw - 19/64" x 3½" - Bag of 24	51.25	-	-
39430	Wood - GRK Post Screw - 5/16" x 4" - Box of 25	26.41	-	-
39433	Wood - GRK Post Screw - 5/16" x 4" - Box of 100	88.03	-	-
39436	Wood - GRK Post Screw - 5/16" x 4" - Box of 400	294.07	-	-
<b>ITEM #</b>	<b>ACCESSORIES</b>	<b>TBL</b>	<b>TBZ</b>	<b>TWH</b>
15610	Advantage Rail Bracket Pack - Level - 4 pc	52.89	52.89	52.89
15613	Advantage Rail Bracket Pack - Stair - 4 pc	60.30	60.30	60.30
15616	Advantage Universal Swivel Rail Bracket Pack - 4 pc	101.07	101.07	101.07
15630	Advantage Drink Rail Bracket Pack - Level - 2 pc	31.39	31.39	31.39
39315	Deck Board Railing Connector	30.41	-	-
15800	Advantage Drink Rail Adapter - 6'	80.86	80.86	80.86
15802	Advantage Drink Rail Adapter - 8'	98.83	98.83	98.83
15820	Advantage Rail - Foot Block	8.33	8.33	8.33
15823	Advantage Cross Over Bracket Adapter - 2½"	123.36	123.36	123.36
15830	Advantage Touch Up Paint - 4.5oz	24.97	24.97	24.97
<b>ITEM #</b>	<b>GATES &amp; HARDWARE</b>	<b>TBL</b>	<b>TBZ</b>	<b>TWH</b>
15365	Advantage VertiRod - Gate Kit - 36"x48"	507.52	507.52	507.52
17751	Self Closing Gate Hinge Set	58.55	-	58.55
17752	Gate Latch	50.25	-	50.25



#15454 & #15455  
3-1/2" Structural Post (Trim not included)

#15478 & #15480  
6" Post Wrap (Trim not included)

#15770  
6" 2-Piece Post Trim

#15753  
3-1/2" Post Trim

COLORS: Textured Black (TBL), Textured Bronze (TBZ), Textured White (TWH)

ITEM #		POSTS & POST WRAPS	TBL	TBZ	TWH
15454	Structural Post 3½"x108" (w/ Mounting Brackets)		306.00	306.00	306.00
15455	Structural Post 3½"x120" (w/ Mounting Brackets) - OVERSIZED		306.00	306.00	306.00
15478	Post Wrap - 4 Piece - 6"x108"		338.22	338.22	338.22
15480	Post Wrap - 4 Piece - 6"x120" - OVERSIZED		338.22	338.22	338.22
ITEM #		ACCESSORIES	TBL	TBZ	TWH
15753	Post Trim - 3½"		27.51	27.51	27.51
15770	Post Trim - 6" - 2 Piece		60.83	60.83	60.83
39410	Concrete - GRK Post Screw - 19/64" x 3½" - Bag of 24		51.25	-	-
39430	Wood - GRK Post Screw - 5/16" x 4" - Box of 25		26.41	-	-
39433	Wood - GRK Post Screw - 5/16" x 4" - Box of 100		88.03	-	-
39436	Wood - GRK Post Screw - 5/16" x 4" - Box of 400		294.07	-	-

# EXTERNAL CABLE FITTINGS

2025 Price Book

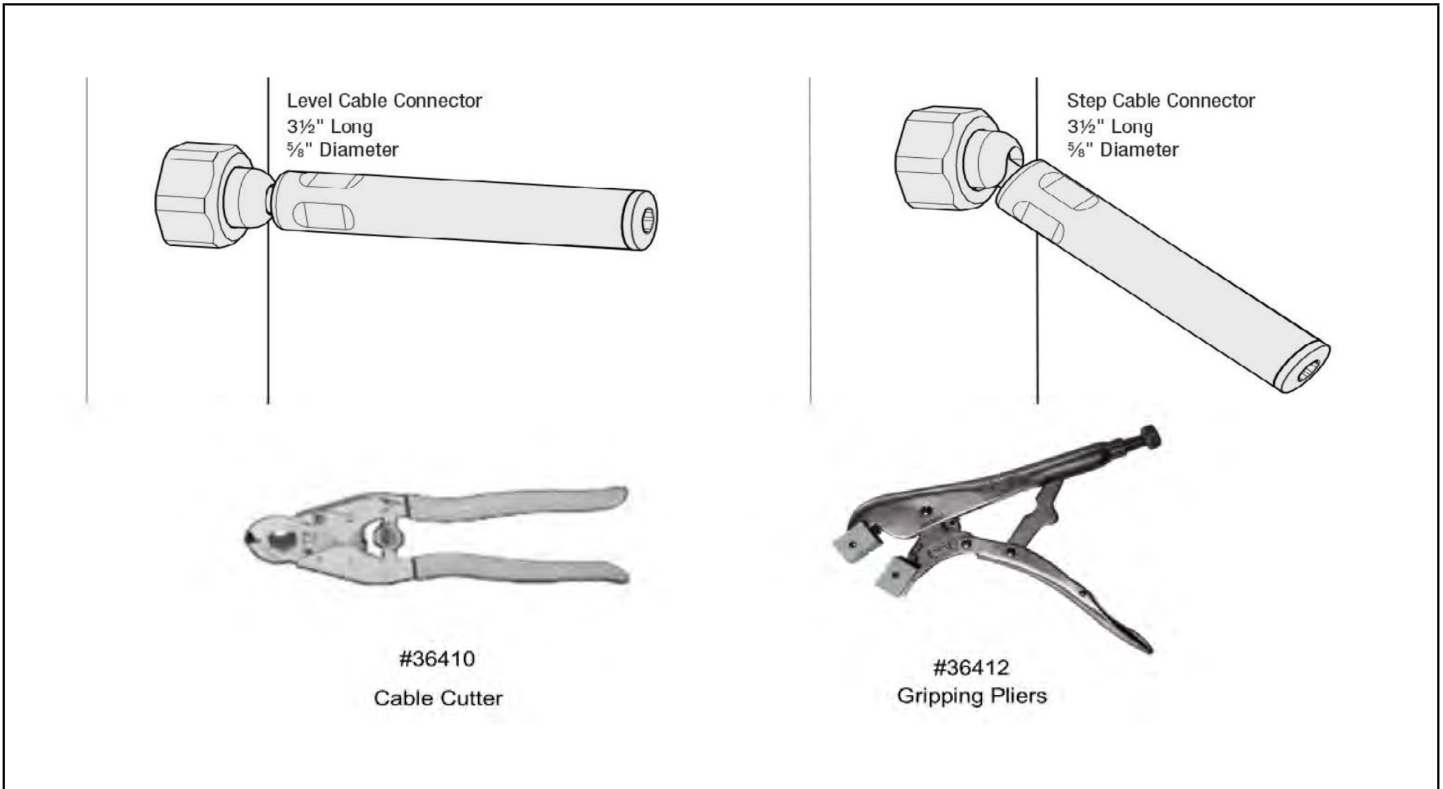

Stainless Steel (Fittings) OR Textured Black, Textured Bronze, Textured White (Accessories)

ITEM #	EXTERNAL CABLE FITTINGS	STAINLESS
18480	Level External Cable Fitting (2 Fittings)	73.95
18481	Level External Cable Fitting (10 Fittings)	352.13
18482	Stair External Cable Fitting (2 Fittings)	77.65
18483	Stair External Cable Fitting (10 Fittings)	369.74
ITEM #	ACCESSORIES	TBL, TBZ, TWH
18492	Cable Intermediate Baluster (with Mounts and Fasteners) - Level	23.30
18495	Cable Intermediate Baluster (with Mounts and Fasteners) - Stair	26.23
ITEM #	CABLE & TOOLS	N/A
18470	Cable Roll (1/8") - 100 FT	105.04
18471	Cable Roll (1/8") - 250 FT	234.12
18471-B	(NS) Cable Roll-250 FT - Black	841.08
18472	Cable Roll (1/8") - 500 FT	433.33
36410	Felco C7 Cable Cutter	105.40
36412	Cable Gripping Pliers	61.48
36420	Loos PT-1 Cable Tension Gauge	205.79
36424	Key-Link Cable Installation Kit w/ Release Tool	15.16
36430	Cable Threading Needle	7.02
36432	3/16" Cable Allen Wrench	1.69
36441	Boeshield Cable Rust & Corrosion Protection T-9 (4 oz.)	23.71



# Regal ideas

**REGAL TOP & BOTTOM RAILS**

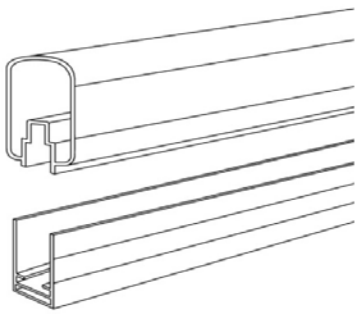

**17003-17009**  
Rails

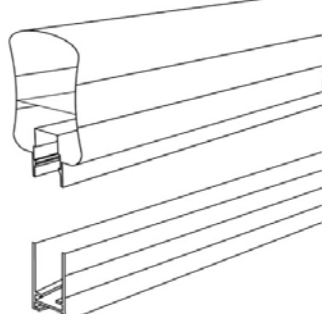

**17020-17023**  
Stair Rails

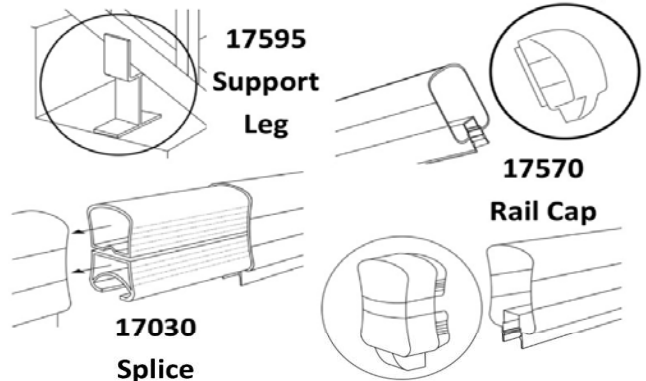

**17595**  
Support  
Leg

**17030**  
Splice

**17570**  
Rail Cap

**17571 - Stair Rail Cap**

**REGAL RAIL INFILL OPTIONS**

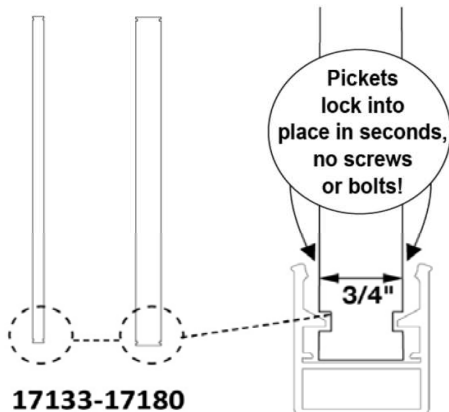

**17133-17180**  
Pickets

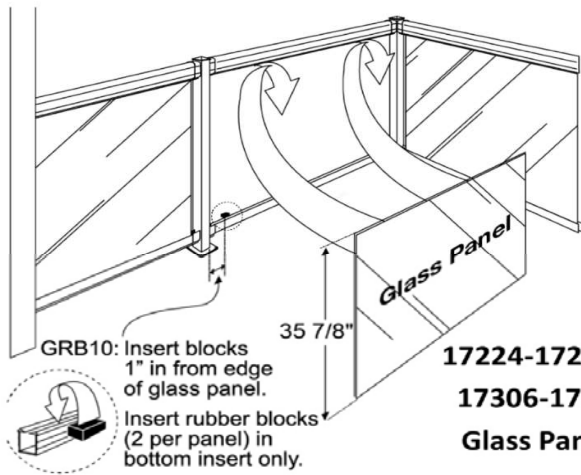

GRB10: Insert blocks 1" in from edge of glass panel.  
Insert rubber blocks (2 per panel) in bottom insert only.

**17224-17266 &  
17306-17366**  
Glass Panels

**(CDG6) HORIZONTAL 7 1/4" GLASS PANELS**

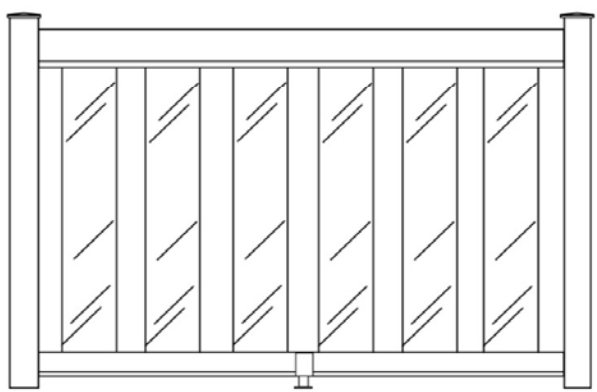

**17390**  
Level Glass Pickets

**(CAG6) STAIR ANGLED 6" GLASS PANELS**

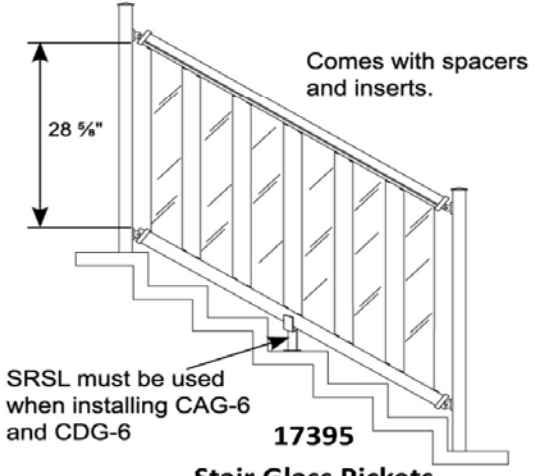

SRSL must be used when installing CAG-6 and CDG-6

**17395**  
Stair Glass Pickets



**REGAL POSTS**

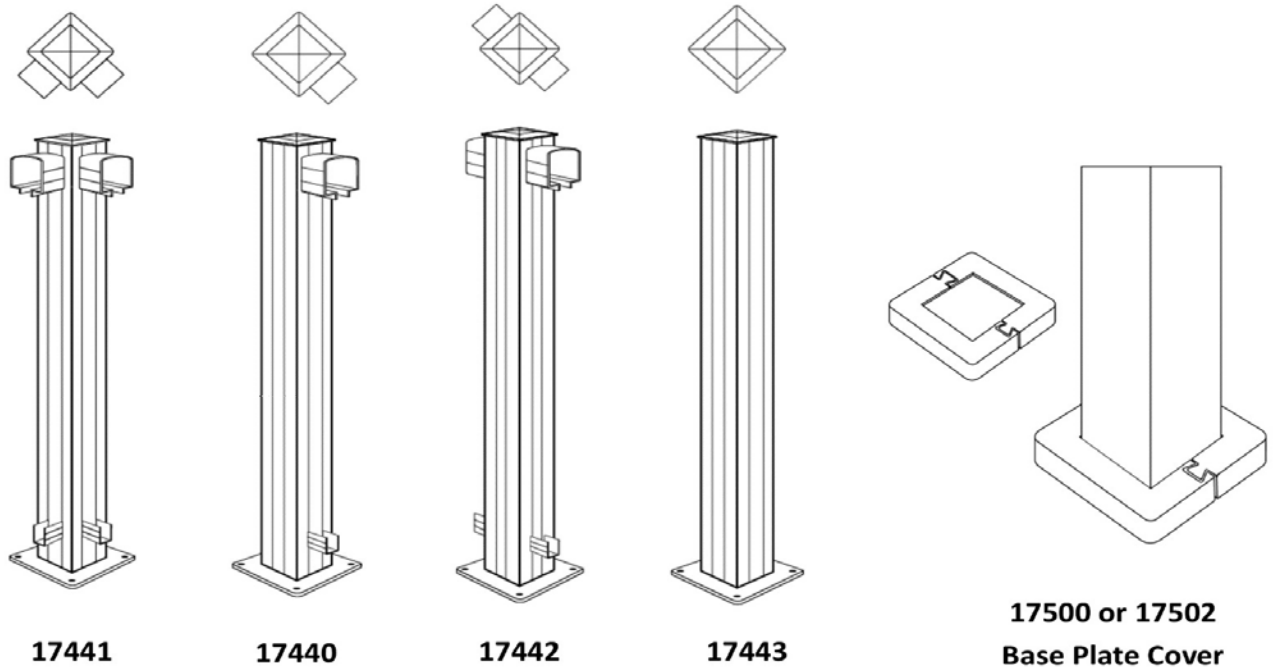
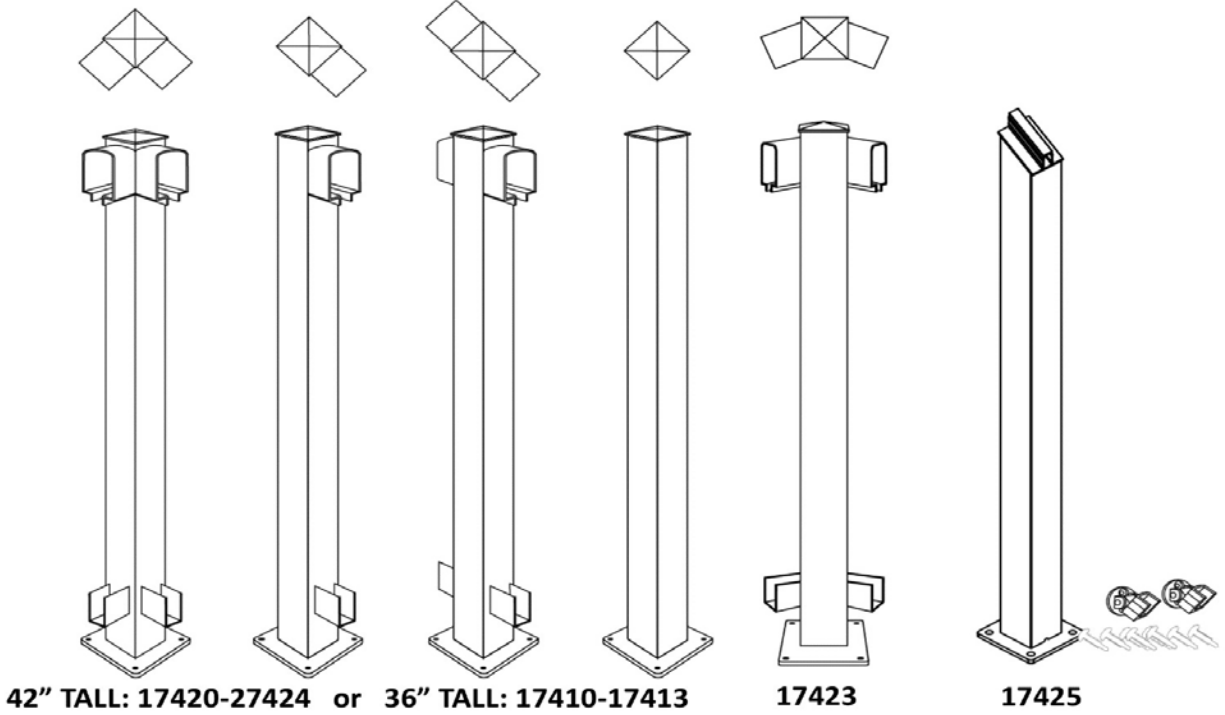

REGAL ACCESSORIES



17512  
Ball Cap

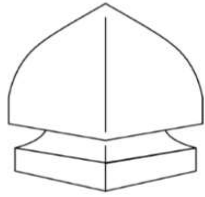

17513  
Pyramid Cap

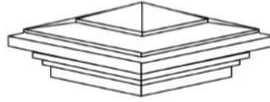

17514  
Tower Cap

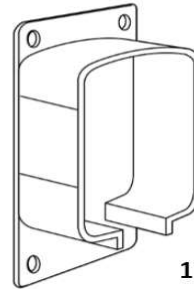

17560 - Wall Bracket

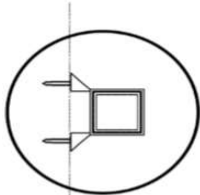
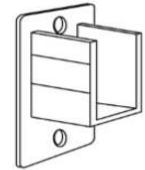

Top View

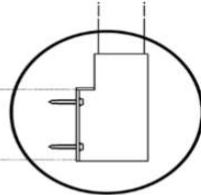

Side View

17540 - Side Mount Bracket

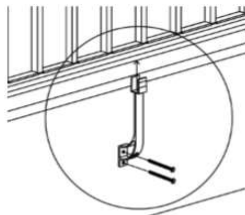

17594 - Side Mount  
Support Leg

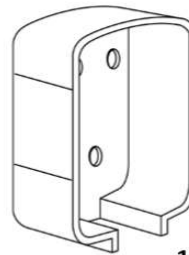

17561 - Post Bracket

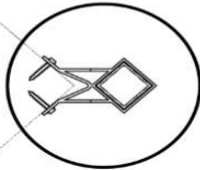
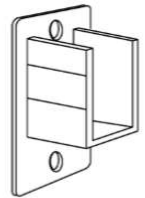

17541 - Side Mount Corner Bracket

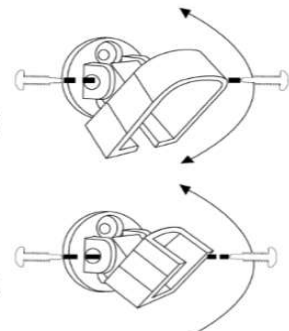
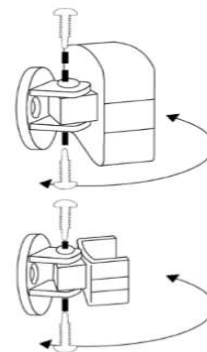
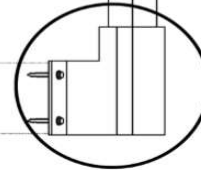

17562 - Universal Swivel Bracket



17300  
Rubber Blocks

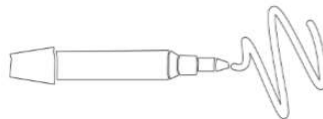

17590  
Touch-up Pen

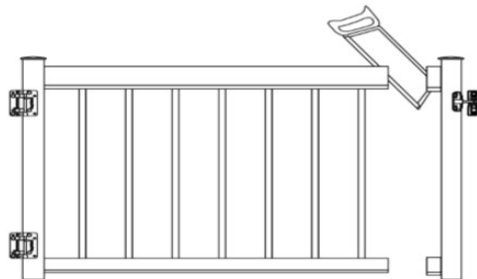

17700, 17710 & 17720  
Gate Kit

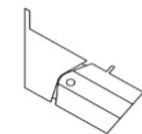
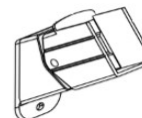
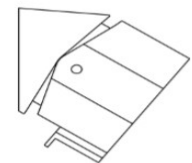
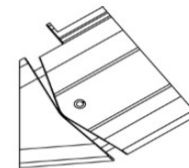

17564 - Universal Stair  
Bracket

REGAL LED LIGHTING

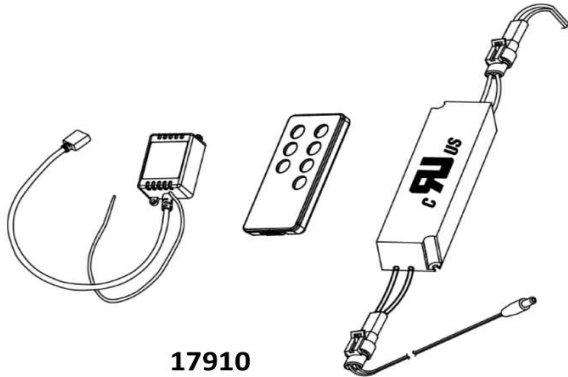

**17910**  
LED Control Pack

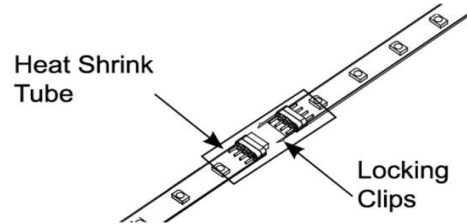

**17900**  
LED Strip

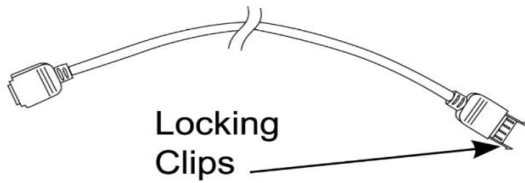

**17911**  
Patch Cord

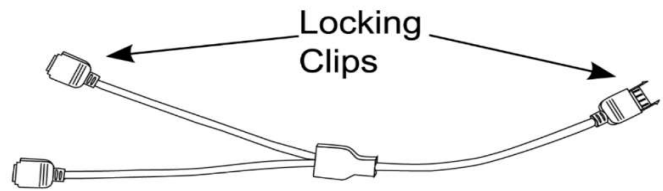

**17912**  
Splitter Cord

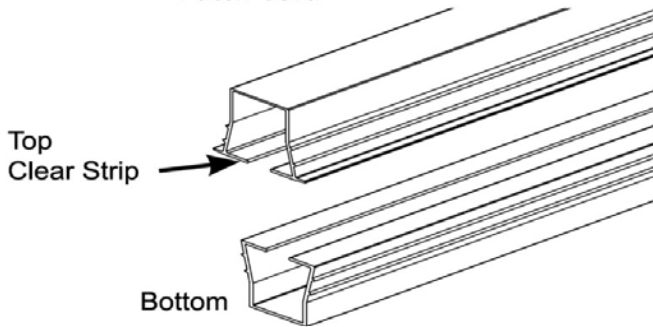

**17302**  
Clear Vinyl Insert

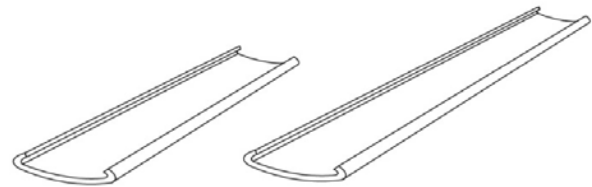

**17581 & 17586**  
Clear Spacers

# REGAL PICKET RAILING

Regal - Textured Black (TBL), Yard Bronze (TBZ), Gloss White (GWH)  
(Windwall - Gloss Black (GBL), Gloss White (GWH))

ITEM #	REGAL ID	LEVEL RAIL PACKS	
17003	TBR-6	Top and Bottom Rails - 6'	152.34
17005	TBR-8	Top and Bottom Rails - 8'	200.18
17007	TBR-10	Top and Bottom Rails - 10'	250.24
17009	TBR-12	Top and Bottom Rails - 12' - OVERSIZED	298.10
ITEM #	REGAL ID	STAIR RAIL PACKS	
17020	STBR-6	Stair Top and Bottom Rails - 6'	170.28
17021	STBR-8	Stair Top and Bottom Rails - 8'	223.71
ITEM #	REGAL ID	LEVEL PICKET PACKS	
17103	SP36-6	¾" Straight Pickets - 36"x6'	129.01
17133	SP-6	¾" Straight Pickets - 42"x6'	141.33
17135	SP-8	¾" Straight Pickets - 42"x8'	184.42
17137	SP-10	¾" Straight Pickets - 42"x10'	230.12
17160	WP-3	1½" Straight Wide Pickets - 42"x3'	88.94
17140	WSP60-6	Wind Wall ¾" Straight Pickets - 60"x6' (GBL & GWH only)	226.27
ITEM #	REGAL ID	STAIR PICKET PACKS	
17153	SPS-6	¾" Straight Pickets - Stair - 36"x6'	141.33
17180	WPS-3	1½" Stair Wide Pickets - 36"x3'	88.94
ITEM #	REGAL ID	POSTS	
17410	REP36	End Post - 2¼"x36"	78.80
17411	RCP36	Corner Post - 2¼"x36"	78.80
17412	RLP36	Line Post - 2¼"x36"	78.80
17413	RSP36	Stair Post - 2¼"x36"	78.80
17420	REP	End Post - 2¼"x42"	86.34
17421	RCP	Corner Post - 2¼"x42"	86.34
17422	RLP	Line Post - 2¼"x42"	86.34
17423	RP45	45° Angle Post - 2¼"x42"	124.63
17424	RSP	Stair Post - 2¼"x42"	86.34
17425	ILSP	In-Line Stair Post - 2¼"x36"	100.67
17440	RP4E	End Post - 4"x42"	163.51
17441	RP4C	Corner Post - 4"x42"	163.51
17442	RP4L	Line Post - 4"x42"	163.51
17443	RP4S	Stair Post - 4"x42"	163.51
17430	WREP	Wind Wall End Post - 2¼"x60" (GBL & GWH only)	107.96
17431	WRCP	Wind Wall Corner Post - 2¼"x60" (GBL & GWH only)	107.96
17432	WRLP	Wind Wall Line Post - 2¼"x60" (GBL & GWH only)	107.96
ITEM #	REGAL ID	HANDRAIL ACCESSORIES	
17570	HRC	Hand Rail Cap	15.81
17030	STBR-CS	Stair Top and Bottom Rail Connecting Splice	25.39
17571	SHRC	End Cap for Top Stair Rail	15.81
17594	PSSL	Side Mount Support Leg	16.92
17595	SRSL	Support Leg	9.60
17563	HRB	Hand Rail Bracket	32.42
ITEM #	REGAL ID	POST ACCESSORIES	
17500	BC	Base Plate Cover - 2¼"	15.32
17502	BC4	Base Plate Cover - 4"	30.23
17510	PC	Standard Replacement 2¼" Post Cap	7.10
17512	DPC-B	Ball Cap - 2¼"	16.55
17513	DPC-P	Pyramid Cap - 2¼"	21.27
17514	DPC-T	Tower Cap - 2¼"	18.54
17528	GL-H8	Glazelock Plastic Tapered Shims - 12 pack	4.79

# REGAL PICKET RAILING

17540	PSB	2¼" Sidemount Post Bracket	43.06
17541	PSCB	2¼" Sidemount Corner Post Bracket	62.74
17530	MP4	4" Aluminum Bolt-through Mounting Plate	12.80
<b>ITEM #</b>	<b>REGAL ID</b>	<b>ACCESSORIES &amp; FASTENERS</b>	
17560	WB	Wall Bracket Set - (Top/Bottom) - (Req. 6-2½" Lags)	31.46
17561	PB	Post Bracket Set - (Top/Bottom) - (Req. 6-#10x3/4" OR 6-2½" Lags)	31.46
17562	UAB	Universal Angle Bracket Set - (Top/Bottom) - (Req. 6-#10x3/4" OR 6-2½" Lags)	63.55
17564	USB	Universal Stair Bracket Set - (Top/Bottom) - (req. 8 #10x3/4")	72.04
17580	RS4-6	4" Spacers (6 Pk.)	9.52
17585	RS5	5" Stair Spacers	2.62
17590	TUP	Touch-Up Pen	31.77
17620	SCP-24	2½" Lag Screw	19.41
17618	MPSS24	5/16"x6" Self-Drilling Structural Screw (24 Pk.)	94.98
17619	MPSS4	5/16"x6" Self-Drilling Structural Screw (4 Pk.)	15.95
17625	S114	#10x1¼" Self-Drilling Screw	23.99
17626	WCS-50	#10x¾" Self-Drilling Screws	29.52
39410		Concrete - GRK Post Screw - 19/64" x 3½" - Bag of 24	51.25
39430		Wood - GRK Post Screw - 5/16" x 4" - Box of 25	26.41
39433		Wood - GRK Post Screw - 5/16" x 4" - Box of 100	88.03
39436		Wood - GRK Post Screw - 5/16" x 4" - Box of 400	294.07
<b>ITEM #</b>	<b>REGAL ID</b>	<b>GATES &amp; HARDWARE</b>	
17700	ASGP36	36"x48" Gate - Straight ¾" Picket	465.75
17710	ASGP	42"x48" Gate - Straight ¾" Picket	510.64
17720	WGP	42"x48" Gate - Wide 1-9/16" Picket	561.71
17730	WPG60	Wind Wall 60"x48" Gate - Straight ¾" Picket (GBL & GWH only)	631.04
17751	GHS	Self Closing Gate Hinge Set	58.55
17752	GL	Gate Latch	50.25
<b>ITEM #</b>	<b>REGAL ID</b>	<b>HANDRAIL LIGHTING</b>	<b>N/A</b>
17900	LED-L	LED Lighting Strip - 78"	107.89
17910	LED-C	LED Lighting Control Pack	232.32
17911	LED-PC	LED Patch Cord - 13'	15.23
17912	LED-T	LED Splitter Cord	10.63
17581	LED-P	Clear Picket Spacers for LED (15 Pk.)	21.22
17586	LED-SP	Clear Picket Stair Spacers for LED (13 Pk.)	26.49

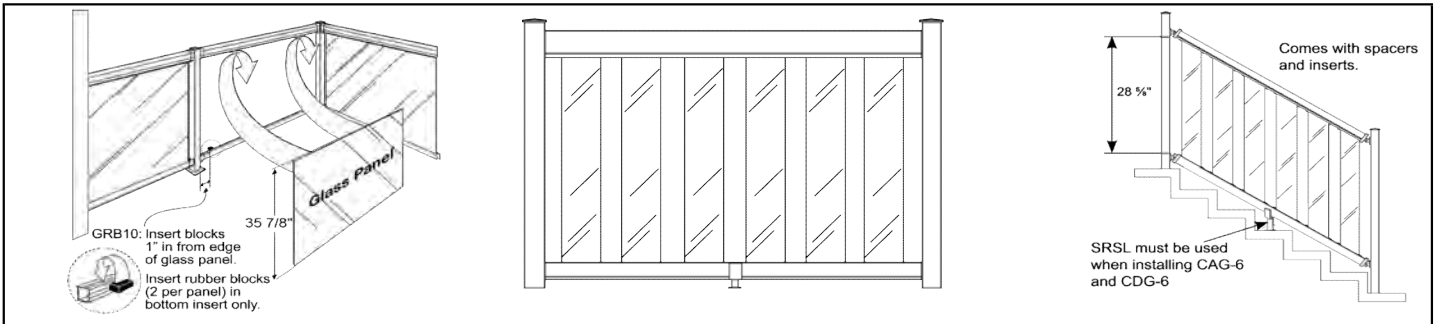

Textured Black (TBL), Yard Bronze (TBZ), Gloss White (GWH)  
**(Windwall - Gloss Black (GBL), Gloss White (GWH))**

ITEM #	REGAL ID	LEVEL RAIL PACKS	
17003	TBR-6	Top and Bottom Rails - 6'	152.34
17005	TBR-8	Top and Bottom Rails - 8'	200.18
17007	TBR-10	Top and Bottom Rails - 10'	250.24
17009	TBR-12	Top and Bottom Rails - 12' - OVERSIZED	298.10
ITEM #	REGAL ID	STAIR RAIL PACKS	
17020	STBR-6	Stair Top and Bottom Rails - 6'	170.28
17021	STBR-8	Stair Top and Bottom Rails - 8'	223.71
ITEM #	REGAL ID	TEMPERED GLASS PANELS FOR 36" HIGH RAILING	GLASS
17224	CG36-24	29 7/8"x24"x1/4" Glass Panel	85.93
17230	CG36-30	29 7/8"x30"x1/4" Glass Panel	107.42
17236	CG36-36	29 7/8"x36"x1/4" Glass Panel	128.91
17242	CG36-42	29 7/8"x42"x1/4" Glass Panel	150.36
17248	CG36-48	29 7/8"x48"x1/4" Glass Panel	171.85
17254	CG36-54	29 7/8"x54"x1/4" Glass Panel	193.32
17260	CG36-60	29 7/8"x60"x1/4" Glass Panel	214.82
17266	CG36-66	29 7/8"x66"x1/4" Glass Panel	236.31
ITEM #	REGAL ID	TEMPERED GLASS PANELS FOR 42" HIGH RAILING	GLASS
17390	CDG-6	7 1/4" Clear Glass Panels for 6' Level Section	220.84
17306	CTG-6	35 7/8"x6"x1/4" Glass Panel	94.18
17309	CTG-9	35 7/8"x9"x1/4" Glass Panel	94.18
17312	CTG-12	35 7/8"x12"x1/4" Glass Panel	94.18
17315	CTG-15	35 7/8"x15"x1/4" Glass Panel	94.18
17318	CTG-18	35 7/8"x18"x1/4" Glass Panel	94.18
17321	CTG-21	35 7/8"x21"x1/4" Glass Panel	94.18
17324	CTG-24	35 7/8"x24"x1/4" Glass Panel	94.18
17327	CTG-27	35 7/8"x27"x1/4" Glass Panel	117.70
17330	CTG-30	35 7/8"x30"x1/4" Glass Panel	117.70
17333	CTG-33	35 7/8"x33"x1/4" Glass Panel	141.28
17336	CTG-36	35 7/8"x36"x1/4" Glass Panel	141.28
17339	CTG-39	35 7/8"x39"x1/4" Glass Panel	164.81
17342	CTG-42	35 7/8"x42"x1/4" Glass Panel	164.81
17345	CTG-45	35 7/8"x45"x1/4" Glass Panel	188.33
17348	CTG-48	35 7/8"x48"x1/4" Glass Panel	188.33
17351	CTG-51	35 7/8"x51"x1/4" Glass Panel	211.96
17354	CTG-54	35 7/8"x54"x1/4" Glass Panel	211.96
17357	CTG-57	35 7/8"x57"x1/4" Glass Panel	235.46
17360	CTG-60	35 7/8"x60"x1/4" Glass Panel	235.46
17363	CTG-63	35 7/8"x63"x1/4" Glass Panel	259.06
17366	CTG-66	35 7/8"x66"x1/4" Glass Panel	259.06
ITEM #	REGAL ID	TEMPERED GLASS PANELS FOR 60" HIGH RAILING	GLASS

# REGAL GLASS RAILING

17370	CTWG-31	53 7/8"x31"x1/4" Wind Wall Glass	199.08
17382	CTWG-43	53 7/8"x43"x1/4" Wind Wall Glass	261.43
<b>ITEM #</b>	<b>REGAL ID</b>	<b>STAIR TEMPERED GLASS PANELS</b>	<b>GLASS</b>
17395	CAG-6	6" Clear Angled Glass Panels for 6' Stair Section	167.62
<b>ITEM #</b>	<b>REGAL ID</b>	<b>POSTS</b>	
17410	REP36	End Post - 2 1/4"x36"	78.80
17411	RCP36	Corner Post - 2 1/4"x36"	78.80
17412	RLP36	Line Post - 2 1/4"x36"	78.80
17413	RSP36	Stair Post - 2 1/4"x36"	78.80
17420	REP	End Post - 2 1/4"x42"	86.34
17421	RCP	Corner Post - 2 1/4"x42"	86.34
17422	RLP	Line Post - 2 1/4"x42"	86.34
17423	RP45	45° Angle Post - 2 1/4"x42"	124.63
17424	RSP	Stair Post - 2 1/4"x42"	86.34
17425	ILSP	In-Line Stair Post - 2 1/4"x36"	100.67
17440	RP4E	End Post - 4"x42"	163.51
17441	RP4C	Corner Post - 4"x42"	163.51
17442	RP4L	Line Post - 4"x42"	163.51
17443	RP4S	Stair Post - 4"x42"	163.51
17430	WREP	Wind Wall End Post - 2 1/4"x60" (GBL & GWH only)	107.96
17431	WRCP	Wind Wall Corner Post - 2 1/4"x60" (GBL & GWH only)	107.96
17432	WRLP	Wind Wall Line Post - 2 1/4"x60" (GBL & GWH only)	107.96
<b>ITEM #</b>	<b>REGAL ID</b>	<b>HANDRAIL ACCESSORIES</b>	
17300	GRB-10	Rubber Blocks for Glass	4.92
17302	LED-G	Clear Vinyl Insert for Glass for LED - 69"	47.40
17570	HRC	Hand Rail Cap	15.81
17030	STBR-CS	Stair Top and Bottom Rail Connecting Splice	25.39
17571	SHRC	End Cap for Top Stair Rail	15.81
17594	PSSL	Side Mount Support Leg	16.92
17595	SRSL	Support Leg	9.60
17563	HRB	Hand Rail Bracket	32.42
<b>ITEM #</b>	<b>REGAL ID</b>	<b>POST ACCESSORIES</b>	
17500	BC	Base Plate Cover - 2 1/4"	15.32
17502	BC4	Base Plate Cover - 4"	30.23
17510	PC	Standard Replacement 2 1/4" Post Cap	7.10
17512	DPC-B	Ball Cap - 2 1/4"	16.55
17513	DPC-P	Pyramid Cap - 2 1/4"	21.27
17514	DPC-T	Tower Cap - 2 1/4"	18.54
17528	GL-H8	Glazelock Plastic Tapered Shims - 12 pack	4.79
17540	PSB	2 1/4" Sidemount Post Bracket	43.06
17541	PSCB	2 1/4" Sidemount Corner Post Bracket	62.74
17530	MP4	4" Aluminum Bolt-through Mounting Plate	12.80
<b>ITEM #</b>	<b>REGAL ID</b>	<b>ACCESSORIES &amp; FASTENERS</b>	
17560	WB	Wall Bracket Set - (Top/Bottom) - (Req. 6-2 1/2" Lags)	31.46
17561	PB	Post Bracket Set - (Top/Bottom) - (Req. 6-#10x3/4" OR 6-2 1/2" Lags)	31.46
17562	UAB	Universal Angle Bracket Set - (Top/Bottom) - (Req. 6-#10x3/4" OR 6-2 1/2" Lags)	63.55
17564	USB	Universal Stair Bracket Set - (Top/Bottom) - (req. 8 #10x3/4")	72.04
17590	TUP	Touch-Up Pen	31.77
17620	SCP-24	2 1/2" Lag Screw	19.41
17618	MPSS24	5/16"x6" Self-Drilling Structural Screw (24 Pk.)	94.98
17619	MPSS4	5/16"x6" Self-Drilling Structural Screw (4 Pk.)	15.95
17625	S114	#10x1 1/4" Self-Drilling Screw	23.99
17626	WCS-50	#10x3/4" Self-Drilling Screws	29.52

# REGAL GLASS RAILING

39410		Concrete - GRK Post Screw - 19/64" x 3½" - Bag of 24	51.25
39430		Wood - GRK Post Screw - 5/16" x 4" - Box of 25	26.41
39433		Wood - GRK Post Screw - 5/16" x 4" - Box of 100	88.03
39436		Wood - GRK Post Screw - 5/16" x 4" - Box of 400	294.07
ITEM #	REGAL ID	HANDRAIL LIGHTING	N/A
17900	LED-L	LED Lighting Strip - 78"	107.89
17910	LED-C	LED Lighting Control Pack	232.32
17911	LED-PC	LED Patch Cord - 13'	15.23
17912	LED-T	LED Splitter Cord	10.63
17581	LED-P	Clear Picket Spacers for LED (15 Pk.)	21.22
17586	LED-SP	Clear Picket Stair Spacers for LED (13 Pk.)	26.49



**CRYSTAL RAIL**

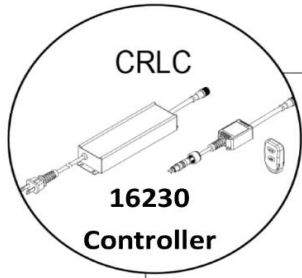

**CRLC**  
**16230**  
**Controller**

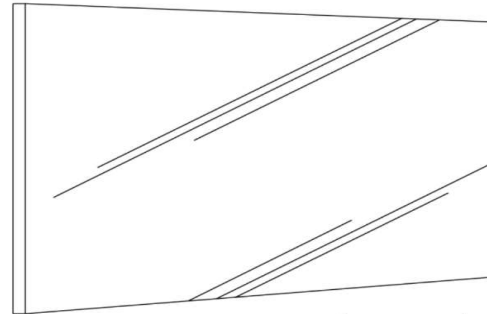

**16024-16060 - Glass Panel**

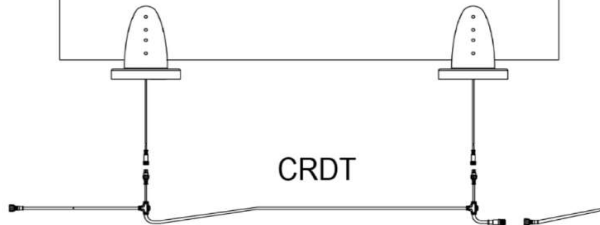

**16231 - Double-T Splitter Cord**

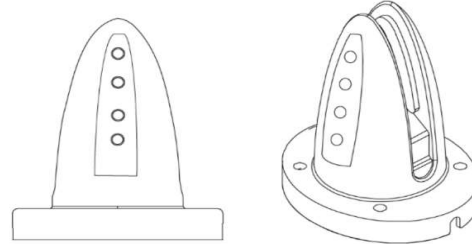

**16200-16201 - Glass Mounts**

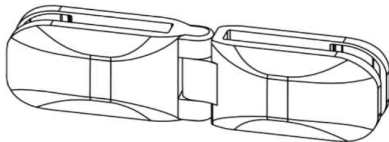

**16210 - Line Clip**



**17623 - Bolt w/ Nut**

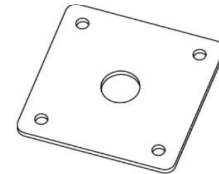

**17531**  
**Mounting Plate**

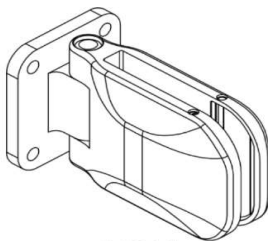

**16211**  
**Wall Clip**

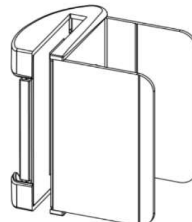

**16212**  
**End Clip**

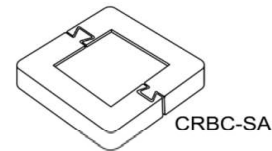

**16221**  
**Base Plate Cover**

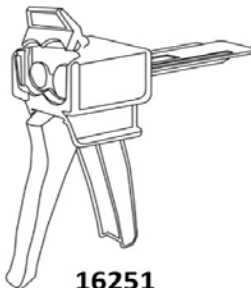

**16251**  
**Glue Dispenser**

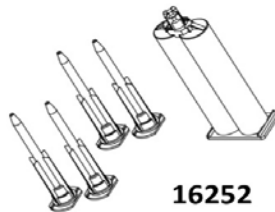

**16252**  
**Adhesive**

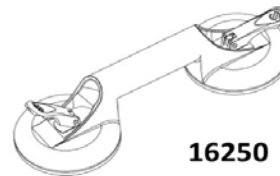

**16250**  
**Vacuum Cup**

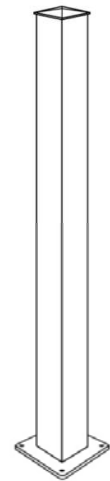

**16220**  
**Post**

Satin Aluminum (SAL)			
ITEM #	REGAL ID	LEVEL & STAIR GLASS MOUNTS & HARDWARE	
16200	CRH	Crystal Rail Horizontal Glass Mount with LED	194.23
16201	CRHS	Crystal Rail Stair Horizontal Glass Mount with LED	206.16
17531	MP5	5" Aluminum Bolt-through Mounting Plate	16.11
17622	MBC	4" SS Concrete Anchor	28.30
17623	MB6	3/8" x 6" Bolt w/ Nut	26.49
ITEM #	REGAL ID	LIGHTING FOR GLASS MOUNTS	BLACK
16230	CRLC	Crystal Rail LED Controller	487.63
16231	CRDT	Crystal Rail Double-T Splitter Connection Cord	59.07
ITEM #	REGAL ID	LEVEL WHITE NO IRON TEMPERED GLASS PANELS	GLASS
16024	CRG24	Crystal Rail 3/8" Glass Panel - 24"x40"	335.63
16030	CRG30	Crystal Rail 3/8" Glass Panel - 30"x40"	420.81
16036	CRG36	Crystal Rail 3/8" Glass Panel - 36"x40"	501.00
16042	CRG42	Crystal Rail 3/8" Glass Panel - 42"x40"	586.14
16048	CRG48	Crystal Rail 3/8" Glass Panel - 48"x40"	671.34
16054	CRG54	Crystal Rail 3/8" Glass Panel - 54"x40"	751.06
16060	CRG60	Crystal Rail 3/8" Glass Panel - 60"x40"	836.63
ITEM #	REGAL ID	STAIR WHITE NO IRON TEMPERED GLASS PANELS	GLASS
16103	CRSG03	Crystal Rail 3/8" Glass Panel for 35° Stair - 3 Steps	702.33
16104	CRSG04	Crystal Rail 3/8" Glass Panel for 35° Stair - 4 Steps	854.65
16105	CRSG05	Crystal Rail 3/8" Glass Panel for 35° Stair - 5 Steps	1006.97
ITEM #	REGAL ID	ACCESSORIES & FASTENERS	
16250	CVC	Crystal Rail Vacuum Cup	78.04
16251	CRGG	Crystal Rail Glue Dispenser	47.10
16252	CREG	Crystal Rail 2 Part Acrylic Adhesive	42.69
16210	CRBA	Crystal Rail Angle and Line Clip	39.85
16211	CRBW	Crystal Rail Adjustable Wall Bracing Clip	24.70
16212	CRBE	Crystal Rail End Brace Clip	34.03
16220	CRSP	Crystal Rail End Bracing Support Post	106.69
16221	CRBC	Crystal Rail Base Plate Cover for Support Post	20.17
17618	MPSS24	5/16"x6" Self-Drilling Structural Screw (24 Pk.)	94.98
17619	MPSS4	5/16"x6" Self-Drilling Structural Screw (4 Pk.)	15.95
ITEM #	REGAL ID	CRYSTAL RAIL ADA HAND/STAIR RAIL	
37150	HR08	8' Handrail	97.63
37151	HSC	Rail Splice and Cap	12.32
37152	HAC	Adjustable Angle Connector	38.98
37153	HBW	Post/Wall Bracket	31.35
37154	HW90	Rail - 90° Wall Return	35.99
37155	HEC	End Rail Cap	8.33
37156	HE5	5° Elbow	43.05
37157	HE35	35° Elbow	44.24
37158	HCR	90° Corner/Return Section	68.39
37159	HLR	Handrail Loop	58.86
37160	HWC	Rail - Wall/Post Return Connector	16.03
37161	HBP	Picket Bracket	20.33
37162	HBG	3/8" Glass Bracket	40.23
37163	HGC	Crystal Rail Epoxy Mounted Handrail Bracket	29.92
37164	HSF	Crystal Rail Sleeve Fitting	8.70
17626	WCS-50	#10x3/4" Self-Drilling Screws	29.52

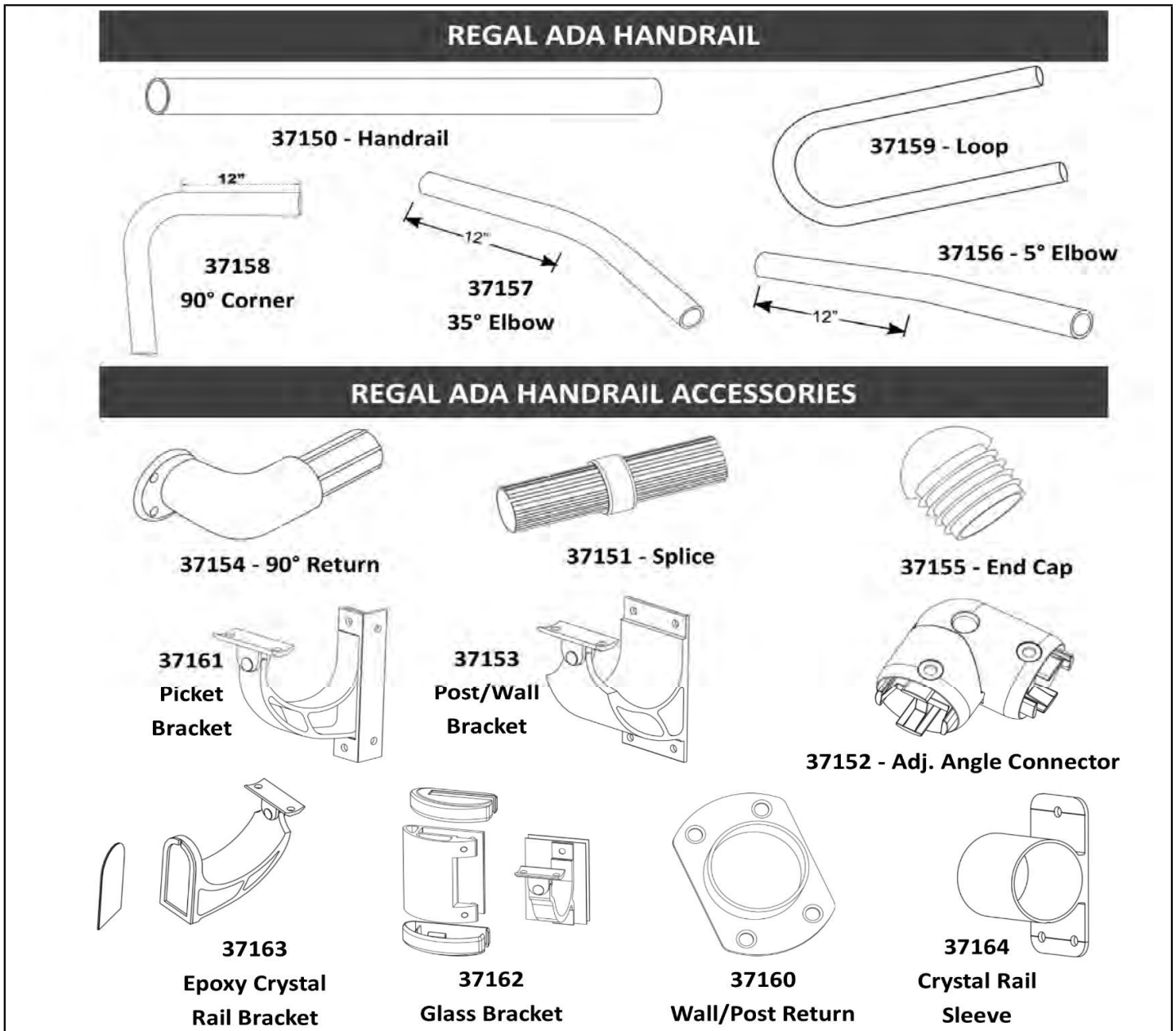

COLOR: Satin Aluminum (SAL)

ITEM #	REGAL ID	REGAL ADA HANDRAIL	SAL
37150	HR08	8' Handrail	97.63
37151	HSC	Rail Splice and Cap	12.32
37152	HAC	Adjustable Angle Connector	38.98
37153	HBW	Post/Wall Bracket	31.35
37154	HW90	Rail - 90° Wall Return	35.99
37155	HEC	End Rail Cap	8.33
37156	HE5	5° Elbow	43.05
37157	HE35	35° Elbow	44.24
37158	HCR	90° Corner/Return Section	68.39
37159	HLR	Handrail Loop	58.86
37160	HWC	Rail - Wall/Post Return Connector	16.03
37161	HBP	Picket Bracket	20.33
17626	WCS-50	#10x¾" Self-Drilling Screws	29.52

TELESTEPS LADDERS



**80020**  
Ladder Bag



**80000-80004**  
Ladder



**80026**  
Stand-off/Tool Tray

TELESTEPS LADDERS & ACCESSORIES			PRICE
ITEM #	REGAL ID		
80000	1400E	14' Consumer Line Ladder (1A 250 lbs Rating)	445.44
80001	1600E	16' Consumer Line Ladder (1A 250 lbs Rating)	548.51
80002	1600ET	16' Tactical Professional Line Ladder (1A 300 lbs Rating)	645.48
80003	1600EP	16' Professional Line Ladder (1A 300 lbs Rating)	645.48
80004	1800EP	18' Professional Line Ladder (1A 300 lbs Rating)	745.47
80005	1600EKP	16' Kevlar Non-Conductive Extension Ladder	1568.25
80020	BAGS-TS	Ladder Carry Bag	103.77
80026	TSO	Ladder Stand-off/Tool Tray	97.43





**Kit Includes:**

- 1—2" x 3-1/2" Top Rail with aluminum reinforcing for Top Rail
- 1—2" x 3-1/2" Bottom Rail
- 1-3/8" Square Pickets
- 4—Wall Mount Brackets
- Foot Blocks in Level Sections 6 ft. and longer



#31010  
Pyramid Cap



#31142  
New England Cap



#33021  
New England Trim



#30310  
Level Bracket



#30318  
Stair Bracket



#30338  
45° Bracket Adapter



#30346  
Level Deckboard Bracket



#30350  
Stair Deckboard Bracket



#39917  
Post Mount

COLOR: White (W), Almond (A)

ITEM #	LEVEL RAIL KITS	W	A
10910	Pro Series Vinyl Rail Kit - Level - 36"x6'	224.83	239.14
10912	Pro Series Vinyl Rail Kit - Level - 36"x8'	280.91	298.51
ITEM #	STAIR RAIL KITS	W	A
10915	Pro Series Vinyl Rail Kit - Stair - 36"x6'	208.17	220.88
10918	Pro Series Vinyl Rail Kit - Stair - 36"x8'	332.85	348.80
ITEM #	POST SLEEVES AND ACCESSORIES	W	A
53452	4"x4"x39" Vinyl Post Sleeve	23.40	30.81
53467	4"x4"x45" Vinyl Post Sleeve	28.77	37.85
39917	4"x36/42" Galvanized Angle Wizard Post Mount (for vinyl post sleeves)	78.01	-



# PRO SERIES VINYL RAILING

2025 Price Book

39410	Concrete - GRK Post Screw - 19/64" x 3½" - Bag of 24	51.25	-
39430	Wood - GRK Post Screw - 5/16"x 4" - Box of 25	26.41	-
39433	Wood - GRK Post Screw - 5/16" x 4" - Box of 100	88.03	-
39436	Wood - GRK Post Screw - 5/16" x 4" - Box of 400	294.07	-
ITEM #	ACCESSORIES	W	A
39740	Pro Series Aluminum Insert - 6'	37.48	-
39742	Pro Series Aluminum Insert - 8'	50.36	-
30310	Pro/Series 100 Level Bracket - 2 Pack	12.44	13.68
30318	Pro/Series 100 Stair Bracket - 2 Pack	14.05	15.46
30338	Pro/Series 100 Bracket Adapter - 45° - 2 Pack	23.49	25.84
30346	Pro/Series 100 Deckboard Bracket - Level - 2 Pack	21.35	23.48
30350	Pro/Series 100 Deckboard Bracket - Stair - 2 Pack	24.76	27.24
39315	Deck Board Railing Connector	30.41	-
31010	4" Pyramid Cap	3.74	4.40
31142	4" New England Cap	11.12	12.23
33021	4" New England Post Trim	7.46	8.17
39694	1.5 oz Vinyl Adhesive	9.61	-
39697	6 oz Vinyl Adhesive	29.16	-
ITEM #	GATE	W	A
35150	Pro Series Vinyl Rail Gate Kit - Unassembled - 36"x48"	523.24	581.34
ITEM #	GATE HARDWARE	White/Black	A
17751	Self Closing Gate Hinge Set	58.55	-
17752	Gate Latch	50.25	-





# ALUMINUM SECONDARY HANDRAIL



COLORS: Textured Black (TBL), Textured Bronze (TBZ), Textured White (TWH)

ITEM #	1-1/2" ROUND SECONDARY HANDRAIL	TBL	TBZ	TWH
37210	Round Handrail - 1½"x8'8"	96.28	96.28	96.28
37213	Inline Splice with Collar	14.24	14.24	14.24
37216	External Universal Joiner	76.07	76.07	76.07
37219	Return Bracket - 90°	31.52	31.52	31.52
37222	Inline Mounting Bracket	26.04	26.04	26.04
37225	End Cap	7.03	7.03	7.03
37231	180° P Loop Return	66.04	66.04	66.04
37234	90° Elbow	30.80	30.80	30.80
37237	Inside Corner Bracket	27.68	27.68	27.68

# REGAL ADA HANDRAIL

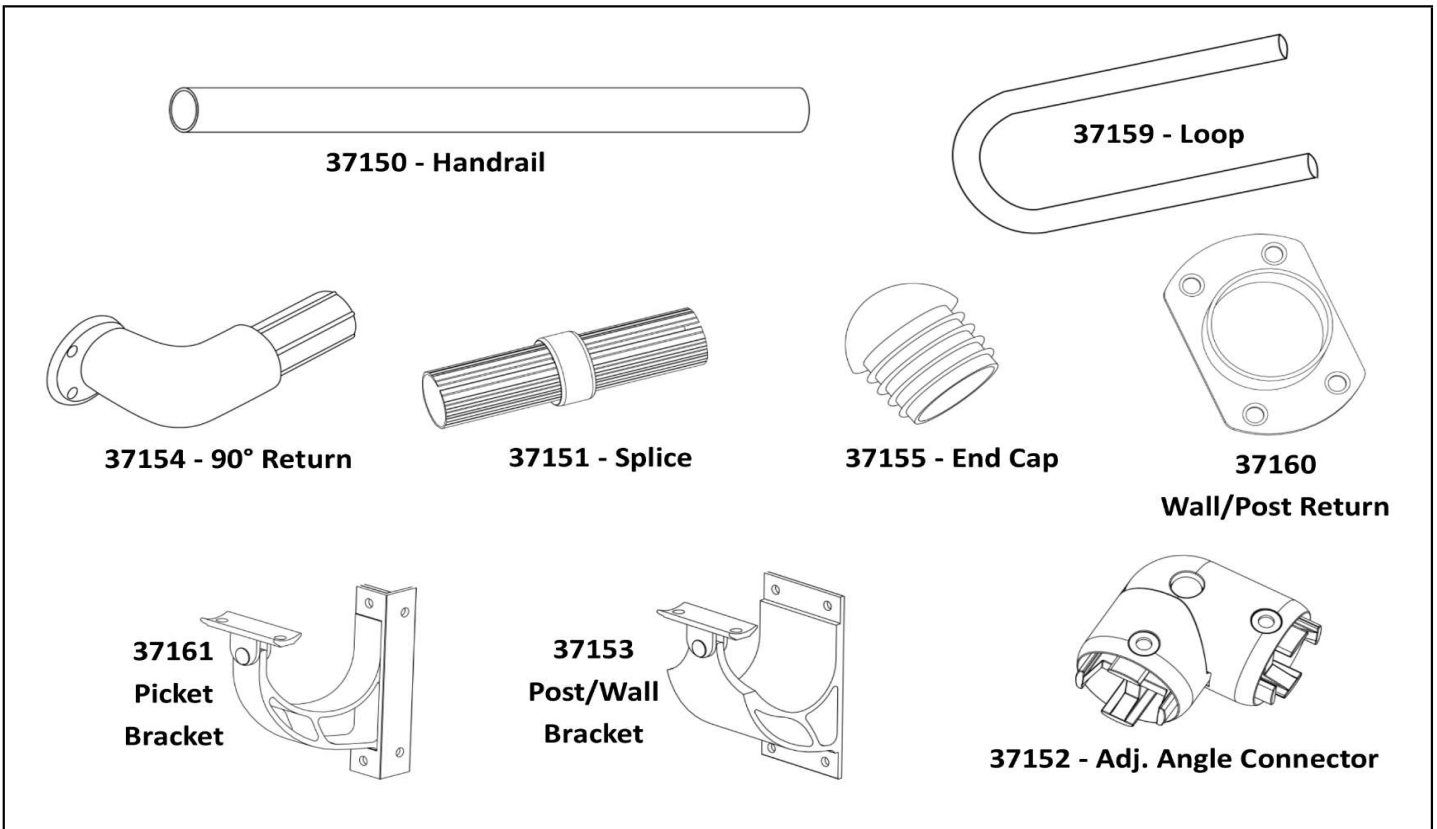

COLOR: Satin Aluminum (SAL)

ITEM #	REGAL ID	REGAL ADA HANDRAIL	SAL
37150	HR08	8' Handrail	97.63
37151	HSC	Rail Splice and Cap	12.32
37152	HAC	Adjustable Angle Connector	38.98
37153	HBW	Post/Wall Bracket	31.35
37154	HW90	Rail - 90° Wall Return	35.99
37155	HEC	End Rail Cap	8.33
37159	HLR	Handrail Loop	58.86
37160	HWC	Rail - Wall/Post Return Connector	16.03
37161	HBP	Picket Bracket	20.33
17626	WCS-50	#10x¾" Self-Drilling Screws	29.52



COLORS: White (W), Almond/Standstone (A), Khaki/Adobe (K), Black (B)

ITEM #	POST SLEEVES AND MOUNTS	W	A	K	B
53452	4"x4"x39" Vinyl Post Sleeve	23.40	30.81	-	47.42
53467	4"x4"x45" Vinyl Post Sleeve	28.77	37.85	-	-
39917	4"x36/42" Galvanized Angle Wizard Post Mount (for vinyl post sleeves)	78.01	-	-	-
39919	5"x36/42" Galvanized Angle Wizard Post Mount (for vinyl post sleeves)	78.01	-	-	-
39410	Concrete - GRK Post Screw - 19/64" x 3½" - Bag of 24	51.25	-	-	-
39430	Wood - GRK Post Screw - 5/16" x 4" - Box of 25	26.41	-	-	-
39433	Wood - GRK Post Screw - 5/16" x 4" - Box of 100	88.03	-	-	-
39436	Wood - GRK Post Screw - 5/16" x 4" - Box of 400	294.07	-	-	-
ITEM #	PORCH POST SLEEVES	W	A	K	B
53541	4"x4"x108" Vinyl Post Sleeve	56.88	62.57	-	88.89
53652	5"x5"x108" Vinyl Post Sleeve	64.42	70.86	-	-
ITEM #	POST WRAPS	W	A	K	B
55037	Vinyl Post Wrap 4"x4"x108" - 4- Piece	164.10	195.97	195.97	-
55038	Vinyl Post Wrap 4"x4"x120" - 4-Piece - OVERSIZED	164.10	195.97	195.97	-
55044	Vinyl Post Wrap 6"x6"x108" - 4-Piece	202.54	261.19	261.19	-
55045	Vinyl Post Wrap 6"x6"x120" - 4-Piece - OVERSIZED	202.54	261.19	261.19	-
ITEM #	STRUCTURAL PORCH POST	W	A	K	B
55020	5"x5"x108" Plain (Square) Structural Vinyl Post	389.55	-	-	-
ITEM #	CAPS, TRIMS, ACCESSORIES	W	A	K	B
31010	4" Pyramid Cap	3.74	4.40	-	-
31016	5" Pyramid Cap	4.84	5.32	-	-
31030	5" Gothic (Spade) Cap	23.22	22.70	-	-
31142	4" New England Cap	11.12	12.23	-	-
31146	5" Classic New England Cap	13.04	15.00	-	-
31148	5" New England Cap	16.31	17.94	-	-
33021	4" New England Post Trim	7.46	8.17	-	-
33025	5" New England Post Trim	13.85	15.24	-	-
33027	6" New England Post Trim	35.89	39.48	-	-
33809	4"-6½" Adj. Classic Post Wrap Trim (4-Piece)	39.75	43.75	45.70	-
36218	5/8" Hole Plug - Bag of 50	19.00	21.50	-	28.00
36225	1" Hole Plug - Bag of 25	17.75	20.00	-	-
ITEM #	LINEALS	W	A	K	B
60266	Vinyl Rail - 1¾" x 3½" x 96" (Rd. Corner)	-	-	-	82.11
60335	Vinyl Rail - 2"x3½"x96"	67.73	78.23	-	-





# 38202  
Ornamental LED Cap



#38200  
Ornamental Downlight Cap



#38313  
Neptune LED Cap



#38358  
Dome Side Light



#38249  
Ornamental Side Light



#38248 & 38244  
Flush Deck Light  
& Trim Ring



#38238  
Stair Riser Light



#38253  
Bistro Lights



#38380, 38382,  
38384 & 38386  
LED Harness



#38397  
2 Output Splitter



#38398  
5 Output Splitter



#38368  
Under Rail LED Strip Light



#38389  
Wire Kit



38401  
50W Power Supply



38400  
12W Power Supply



#38399  
Dimmer w/ Remote

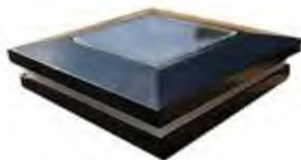

#38521  
Ornamental Solar Cap



#38520  
Ornamental Downward  
Solar Cap



#38613  
Neptune Solar Cap



#38615  
Neptune Downlight  
Solar Cap

COLORS: Textured Black (TBL), Textured Bronze (TBZ), Textured White (TWH), White (W)  
(TEXTURED COLORS ARE MATCHED TO JAM RAILING COLORS)

ITEM #	LOW VOLTAGE POST CAP LIGHTS FOR ALUMINUM	TBL	TBZ	TWH	W
38200	2½" Ornamental Downward Light Cap - LV LED (3k) - (.8W)	57.84	57.84	57.84	-
38202	2½" Ornamental Light Cap - LV LED (3k) - (.8W)	57.84	57.84	57.84	-
38211	3½" Ornamental Light Cap - LV LED (3k) - (.8W)	66.44	-	-	-

ITEM #	SOLAR POST CAP LIGHTS FOR ALUMINUM	TBL	TBZ	TWH	W
38521	2½" Ornamental Solar Light	90.86	90.86	90.86	-
38520	2½" Ornamental Downward Solar Light	75.65	75.65	75.65	-
38531	3½" Ornamental Solar Light	98.82	-	-	-
38530	3½" Ornamental Downward Solar Light	81.97	-	-	-
ITEM #	LOW VOLTAGE POST CAP LIGHTS FOR VINYL	TBL	TBZ	TWH	W
38258	Cape May 4" Post Cap Light - LV - LED (3k) - (.8W)	-	-	-	45.85
38260	Cape May Downward 4" Post Cap Light - LV (3k) - (.8W)	-	-	-	49.09
38313	Neptune 4" Post Cap Light - LV (3k) - (.8W)	-	-	-	50.43
38315	Neptune Downward 4" Post Cap Light - LV (3k) - (.8W)	-	-	-	45.85
ITEM #	SOLAR POST CAP LIGHTS FOR VINYL	TBL	TBZ	TWH	W
38613	Neptune 4" Post Cap Light - Solar	-	-	-	54.49
38615	Neptune Downward 4" Post Cap Light - Solar	-	-	-	57.79
ITEM #	OTHER LOW VOLTAGE LIGHTS	TBL	TBZ	TWH	W
38238	Recessed LV Stair Riser Light (3k) - (.4W)	12.25	12.25	-	12.25
38244	Flush Light Trim (Bag of 10) - (NOT TEXTURED)	17.98	17.98	-	17.98
38248	Flush Deck Light - LV LED 3k - (.4W) - (NO COLOR)	9.72	-	-	-
38249	Ornamental Side Light - LV LED (3k) - (.4W) - Includes all 3 Colors	18.64	18.64	-	18.64
38253	Bistro String Light - 24' - (8 Bulb - 3K LV - 6.4 Watts)	63.95	-	-	-
38350	Stair/Side Light with covers - LV (3k) - (.4W)	-	-	-	12.17
38358	Dome Side Light - LED - LV - (.8W)	-	-	-	16.70
38368	Under Rail LED Strip Light - 92"	112.05	-	-	-
ITEM #	LOW VOLTAGE WIRING & POWER SUPPLIES	N/A	TBZ	TWH	W
38380	2' LV LED Harness	6.30	-	-	-
38382	5' LV LED Harness	8.14	-	-	-
38384	7' LV LED Harness	11.67	-	-	-
38386	9' LV LED Harness	13.91	-	-	-
38389	Wire Kit (5' & 9' Harness, 2-Way Splitter)	29.51	-	-	-
38397	2 Output Splitter - LED LV	7.55	-	-	-
38398	5 Output Splitter - LED LV	14.98	-	-	-
38401	12 Volt/50Watt Power Supply with Photo Eye, Timer, and Remote	279.99	-	-	-



Pergola kits include aluminum inserts for the posts, beams, and rafters.

COLOR: White (W)  
 PRICING FOR ALMOND, CLAY, OR BLACK AVAILABLE UPON REQUEST.  
 PRICING FOR KITS WITH 6" SQUARE, (8" ROUND AVAILABLE UPON REQUEST)

FREE STANDING PERGOLA		WHITE
84100	Pergola - 12x12	6,516.85
84120	Pergola - 12x16	7,741.31
PERGOLA POSTS   POST ACCESSORIES		WHITE
53898	Post Sleeve - 6"x6"x108"	107.99
87102	8" Tapered Pergola Column	435.33
87150	Pergola Column Mount - 6" Square	176.33

87152	8" Round Tapered Pergola Column Mount	278.08
87141	Pergola Square Beam Mount Assembly - 6"	211.07
33027	Post Trim - 6" - New England	35.89
33029	Post Trim - 6" - Federation (2pc)	24.45
31150	6" New England Cap	47.92
<b>ITEM #</b>	<b>PERGOLA RAILS - BEAMS   RAFTERS   INSERTS</b>	<b>WHITE</b>
60407	Rafter - 2"x6"x8' - Hollow	44.82
60418	Rafter - 2"x6"x12' - Hollow	107.89
60427	Rafter - 2"x6"x16' - Hollow	143.84
60482	Beam - 2"x8"x8' - Hollow	58.05
60484	Beam - 2"x8"x12' - Hollow	118.30
60488	Beam - 2"x8"x16' - Hollow	151.16
39854	Aluminum Rafter Insert - 2"x6"x12'	177.53
39856	Aluminum Rafter Insert - 2"x6"x16'	236.73
39848	Aluminum Beam Insert - 2"x8"x12'	297.95
39850	Aluminum Beam Insert - 2"x8"x16'	397.26
<b>ITEM #</b>	<b>PERGOLA SHADE PICKET CANOPY</b>	<b>WHITE</b>
70142	Shade Picket - 7/8"x3"x12'	32.79
70145	Shade Picket - 7/8"x3"x16'	43.71
32017	Shade Picket Cap - Dog Ear - 7/8"x3"	4.64
<b>ITEM #</b>	<b>PERGOLA ACCESSORIES AND HARDWARE</b>	<b>WHITE</b>
87316	Stainless Steel Pergola Rafter Bracket - 2"	7.98
87119	Pergola Rail Cap - Scroll - 2"x6"	47.34
87133	Pergola Rail Cap - Flat - 2"x6"	6.95
87122	Pergola Rail Cap - Scroll - 2"x8"	58.42
87138	Pergola Rail Cap - Flat - 2"x8"	14.03
87165	Beam/Rafter Coupler - 2"x6"	14.73
87173	Beam/Rafter Coupler - 2"x8"	21.9
87375	Rafter Wall Bracket (For Attached Pergolas) - 2"x6"	27.91
36225	Hole Plug - 1"	17.75
39127	Screw - #14x1" Hex Washer Head Tek Screw (For Rafter Bracket) 50 Ct	44.26
39121	Screw - #10x1½ Pan Head Tek Screw (For Pergola Canopy) 50 Ct	0.66
39694	Vinyl Adhesive - 1½ oz.	9.61
39697	Vinyl Adhesive - 6 oz.	29.16





#81014  
Westhaven Arbor



#81011  
Nantucket Deluxe Arbor



#81012  
Nantucket Legacy Arbor



#81013  
Fairfield Arbor



#81010  
Fairfield Deluxe Arbor



#81010  
Livingston Arbor

COLOR: White (W)

ITEM #	FREE STANDING ARBORS	WHITE
81010	Livingston Arbor	703.61
81011	Nantucket Deluxe Arbor	1,172.69
81012	Nantucket Legacy Arbor	1,055.43
81013	Fairfield Arbor	1,407.23
81014	Westhaven Arbor	703.61
81015	Fairfield Deluxe Arbor	1,407.23



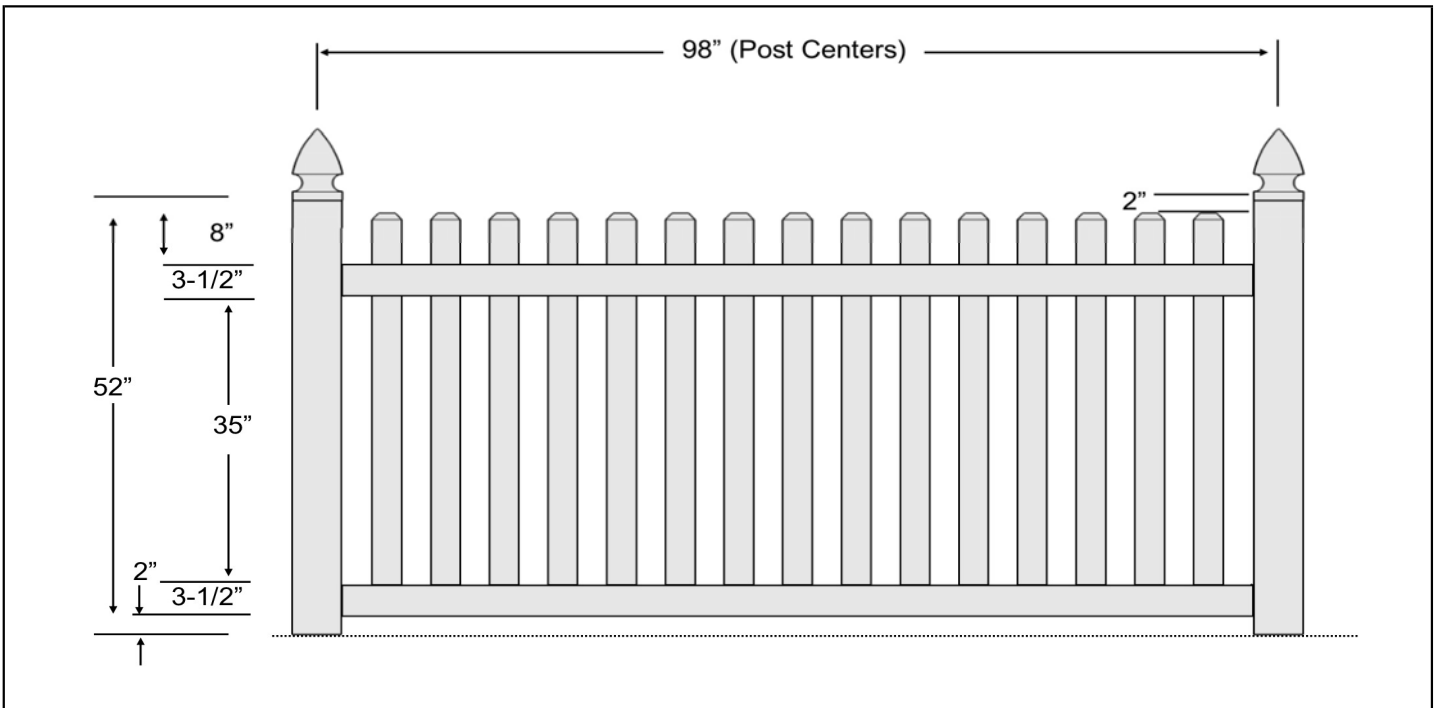

COLORS: White (W), Almond (A)

4' CAMBRIDGE PICKET - FENCE SECTIONS & GATES		WHITE*	ALMOND*
20055	Cambridge - 4'x8' Picket Fence (2" Picket Space) with Dog Ear Caps	306.34	336.97
34032	Cambridge Gate - 4'x4' Picket (2" Spacing)	296.08	325.69
34034	Cambridge Gate - 4'x5' Picket (2" Spacing)	350.19	385.21
4' CAMBRIDGE PICKET POSTS		WHITE	ALMOND
57000	Cambridge Picket (4' Tall) - 5"x5"x78" - End Post	44.37	48.81
57001	Cambridge Picket (4' Tall) - 5"x5"x78" - Line Post	44.37	48.81
57002	Cambridge Picket (4' Tall) - 5"x5"x78" - Corner Post	44.37	48.81
51994	Blank Fence Post - 5"x5"x78"	44.37	48.81
57010	Cambridge Picket (4' Tall) - 5"x5"x5' - End Post	35.38	38.92
57011	Cambridge Picket (4' Tall) - 5"x5"x5' - Line Post	35.38	38.92
57012	Cambridge Picket (4' Tall) - 5"x5"x5' - Corner Post	35.38	38.92
51990	Blank Fence Post - 5"x5"x5'	35.38	38.92
ACCESSORIES		WHITE	ALMOND
31016	5" Pyramid Cap	4.84	5.32
31146	5" Classic New England Cap	13.04	15.00
31148	5" New England Cap	16.31	17.94
31030	5" Gothic (Spade) Cap	23.22	22.70
35600	4' Tall Gate Brace	23.97	28.75
35603	6' Tall Gate Brace	27.73	33.27
HARDWARE		BLACK	ALMOND
39887	5"x5"x96" Gate Post Insert	135.39	-
35380	Keystone 1-Sided External Mount Nylon Latch	41.16	-
35382	Keystone 2-Sided External Mount Nylon Latch	68.28	-
35315	Nationwide Self-Close Adjustable Hinge Pair (4' Tall Gates)	78.06	-
35405	Stainless Steel Drop Rod - 24"	65.83	-
39694	1.5 oz Vinyl Adhesive	9.61	-
39697	6 oz Vinyl Adhesive	29.16	-

**\*NOTE: A minimum fence order fee of \$45 will be added to orders with 10 or less fence panels.**

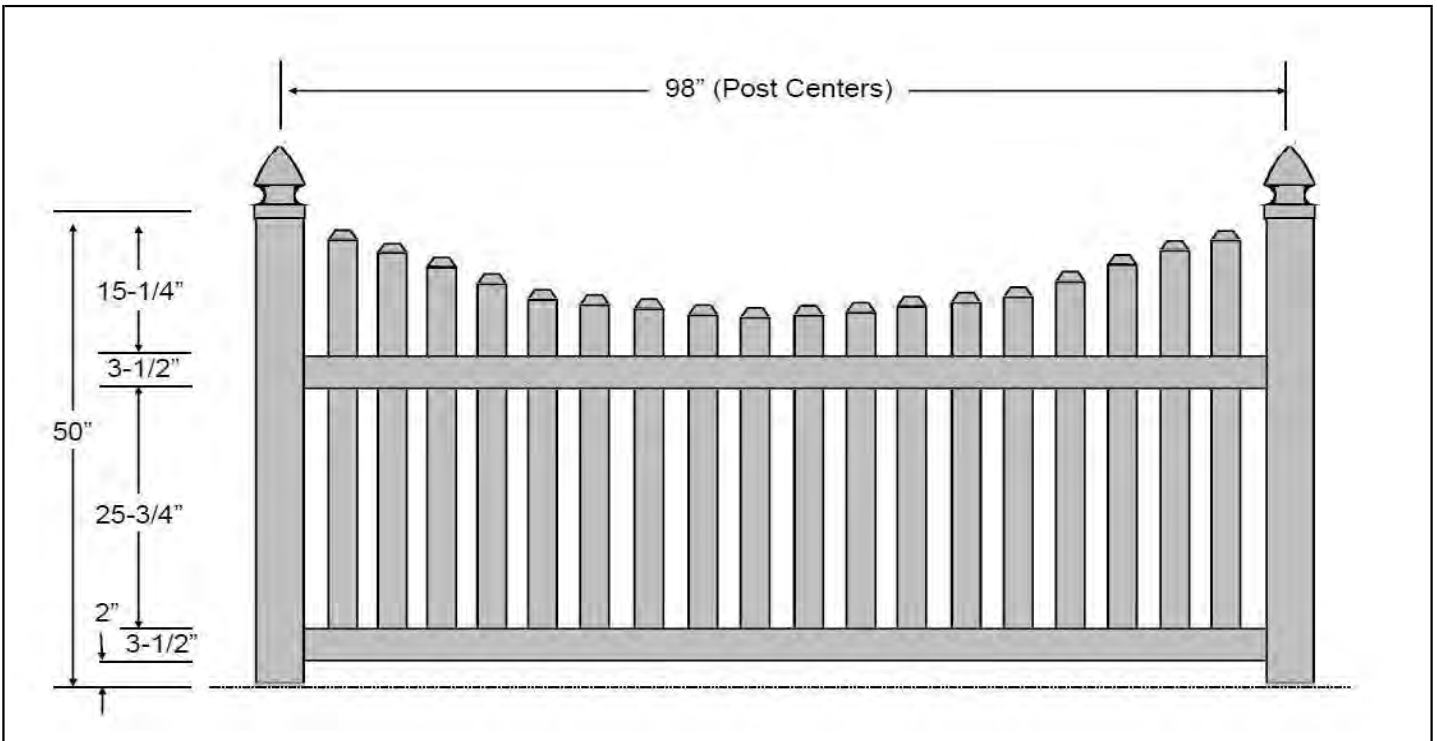

COLORS: White (W), Almond (A)

ITEM #	4' COLUMBIA CONCAVE PICKET - FENCE SECTIONS & GATES	WHITE*	ALMOND*
20116	Columbia (Charleston) - 4'x8' - Scalloped Picket Fence (2" Picket Spacing)	328.85	361.74
34056	Columbia (Charleston) Gate - 4'x4' Picket (2" Spacing)	350.82	385.90
34058	Columbia (Charleston) Gate - 4'x5' Picket (2" Spacing)	413.31	454.64
ITEM #	4' COLUMBIA CONCAVE PICKET POSTS	WHITE	ALMOND
57020	Columbia (Charleston)/ New England Concave - 5"x5"x78" End Post	44.37	48.81
57021	Columbia (Charleston)/ New England Concave - 5"x5"x78" Line Post	44.37	48.81
57022	Columbia (Charleston)/ New England Concave - 5"x5"x78" Corner Post	44.37	48.81
51994	Blank Fence Post - 5"x5"x78"	44.37	48.81
57030	Columbia (Charleston)/ New England Concave - 5"x5"x5' End Post	35.38	38.92
57031	Columbia (Charleston)/ New England Concave - 5"x5"x5' Line Post	35.38	38.92
57032	Columbia (Charleston)/ New England Concave - 5"x5"x5' Corner Post	35.38	38.92
51990	Blank Fence Post - 5"x5"x5'	35.38	38.92
ITEM #	ACCESSORIES	WHITE	ALMOND
31016	5" Pyramid Cap	4.84	5.32
31146	5" Classic New England Cap	13.04	15.00
31148	5" New England Cap	16.31	17.94
31030	5" Gothic (Spade) Cap	23.22	22.70
35600	4' Tall Gate Brace	23.97	28.75
35603	6' Tall Gate Brace	27.73	33.27
ITEM #	HARDWARE	BLACK	ALMOND
39887	5"x5"x96" Gate Post Insert	135.39	-
35380	Keystone 1-Sided External Mount Nylon Latch	41.16	-
35382	Keystone 2-Sided External Mount Nylon Latch	68.28	-
35315	Nationwide Self-Close Adjustable Hinge Pair (4' Tall Gates)	78.06	-
35405	Stainless Steel Drop Rod - 24"	65.83	-
39694	1.5 oz Vinyl Adhesive	9.61	-
39697	6 oz Vinyl Adhesive	29.16	-

**\*NOTE: A minimum fence order fee of \$45 will be added to orders with 10 or less fence panels.**

**5'X8', 6'X8' SEMI-PRIVACY FENCE**

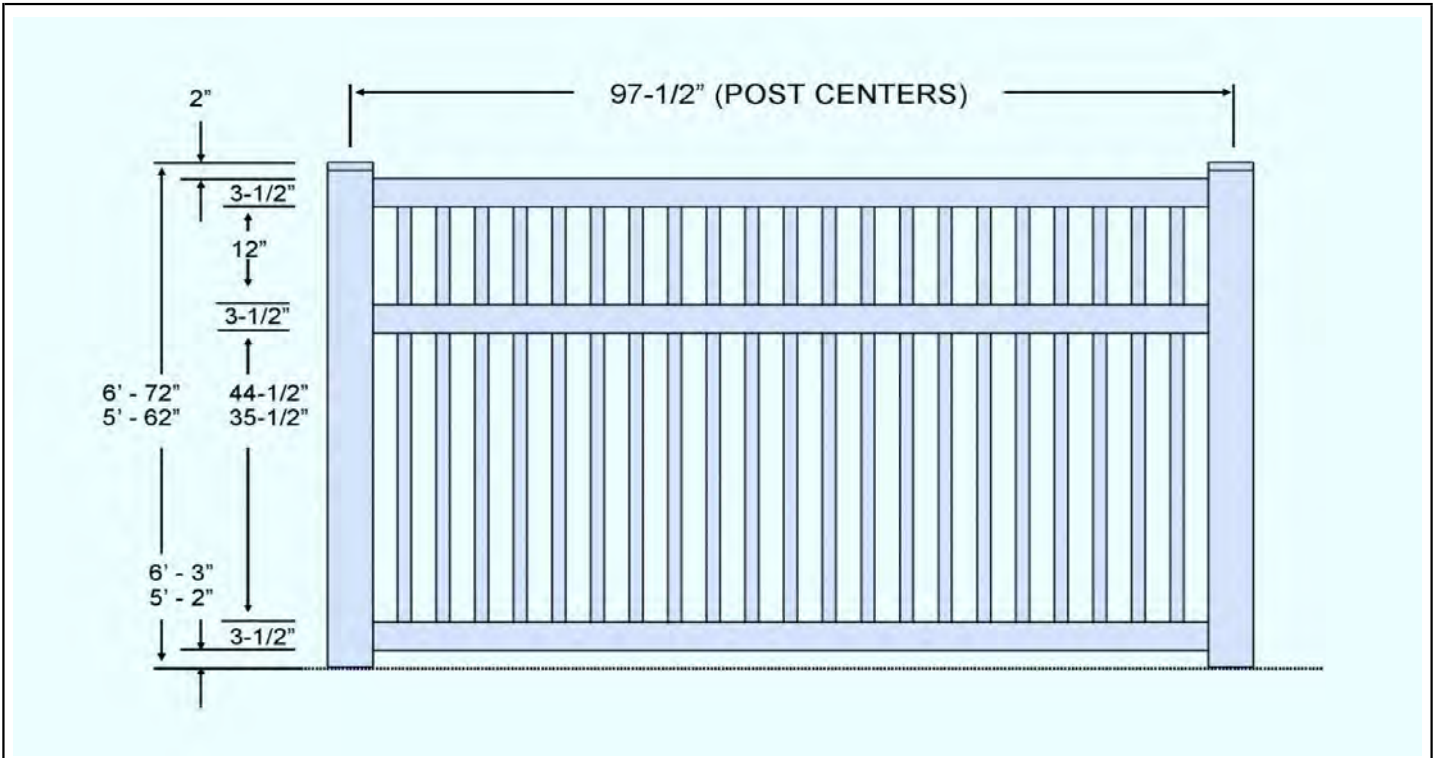

COLORS: White (W), Almond (A)

ITEM #	5' FAIRFIELD - FENCE SECTIONS & GATES	WHITE*	ALMOND*
20160	Fairfield - 5'x8' Picket Fence with Mid-Rail	269.30	296.23
34100	Fairfield Gate - 5'x4' Picket	335.97	369.57
34101	Fairfield Gate - 5'x5' Picket	400.20	440.22
ITEM #	5' FAIRFIELD - POSTS	WHITE	ALMOND
57040	Fairfield/Fairhaven (5' Tall) - 5"x5"x9' - End Post	53.01	58.31
57041	Fairfield/Fairhaven (5' Tall) - 5"x5"x9' - Line Post	53.01	58.31
57042	Fairfield/Fairhaven (5' Tall) - 5"x5"x9' - Corner Post	53.01	58.31
51998	Blank Fence Post - 5"x5"x9'	53.01	58.31
57050	Fairfield/Fairhaven (5' Tall) - 5"x5"x78" - End Post	44.37	48.81
57051	Fairfield/Fairhaven (5' Tall) - 5"x5"x78" - Line Post	44.37	48.81
57052	Fairfield/Fairhaven (5' Tall) - 5"x5"x78" - Corner Post	44.37	48.81
51994	Blank Fence Post - 5"x5"x78"	44.37	48.81
ITEM #	6' FAIRFIELD - FENCE SECTIONS & GATES	WHITE	ALMOND
20162	Fairfield - 6'x8' Picket Fence with Mid-Rail	269.30	296.23
34102	Fairfield Gate - 6'x4' Picket	335.97	369.57
34103	Fairfield Gate - 6'x5' Picket	400.20	440.22
ITEM #	6' FAIRFIELD - POSTS	WHITE	ALMOND
57054	Fairfield/Fairhaven (6' Tall) - 5"x5"x9' - End Post	53.01	58.31
57055	Fairfield/Fairhaven (6' Tall) - 5"x5"x9' - Line Post	53.01	58.31
57056	Fairfield/Fairhaven (6' Tall) - 5"x5"x9' - Corner Post	53.01	58.31
51998	Blank Fence Post - 5"x5"x9'	53.01	58.31
57057	Fairfield/Fairhaven (6' Tall) - 5"x5"x78" - End Post	44.37	48.81
57058	Fairfield/Fairhaven (6' Tall) - 5"x5"x78" - Line Post	44.37	48.81
57059	Fairfield/Fairhaven (6' Tall) - 5"x5"x78" - Corner Post	44.37	48.81
51994	Blank Fence Post - 5"x5"x78"	44.37	48.81
ITEM #	ACCESSORIES	WHITE	ALMOND
31016	5" Pyramid Cap	4.84	5.32
31146	5" Classic New England Cap	13.04	15.00

**5'X8', 6'X8' SEMI-PRIVACY FENCE**

31148	5" New England Cap	16.31	17.94
31030	5" Gothic (Spade) Cap	23.22	22.70
35603	6' Tall Gate Brace	27.73	33.27
<b>ITEM #</b>	<b>HARDWARE</b>	<b>BLACK</b>	<b>ALMOND</b>
39887	5"x5"x96" Gate Post Insert	135.39	-
35380	Keystone 1-Sided External Mount Nylon Latch	41.16	-
35382	Keystone 2-Sided External Mount Nylon Latch	68.28	-
35320	Heavy Duty Self-Close Hinge Pair	97.84	-
35405	Stainless Steel Drop Rod - 24"	65.83	-
35411	Nationwide Gate Handle With Bumper	23.38	-
39694	1.5 oz Vinyl Adhesive	9.61	-
39697	6 oz Vinyl Adhesive	29.16	-

**\*NOTE: A minimum fence order fee of \$45 will be added to orders with 10 or less fence panels.**

**5'X8', 6'X8' SEMI-PRIVACY FENCE**

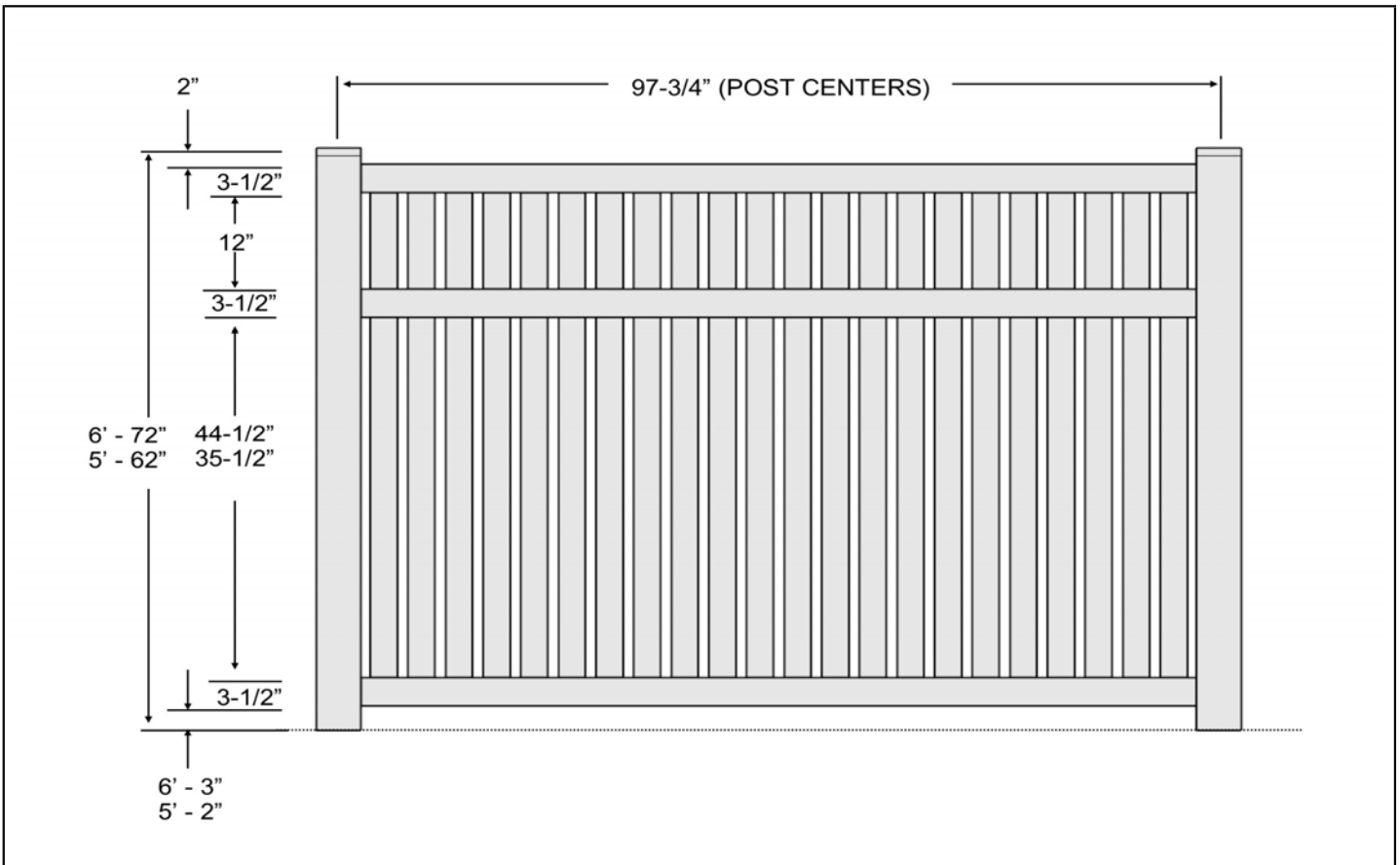

COLORS: White (W), Almond (A)

ITEM #	5' FAIRHAVEN - FENCE SECTIONS & GATES	WHITE*	ALMOND*
20182	Fairhaven - 5'x8' - Semi-Privacy Fence (2" Picket Spacing)	311.63	342.79
34114	Fairhaven Gate - 5'x4' Semi-Privacy (2" Spacing)	368.36	405.20
34115	Fairhaven Gate - 5'x5' Semi-Privacy (2" Spacing)	414.87	456.36
ITEM #	5' FAIRHAVEN - POSTS	WHITE	ALMOND
57040	Fairfield/Fairhaven (5' Tall) - 5"x5"x9' - End Post	53.01	58.31
57041	Fairfield/Fairhaven (5' Tall) - 5"x5"x9' - Line Post	53.01	58.31
57042	Fairfield/Fairhaven (5' Tall) - 5"x5"x9' - Corner Post	53.01	58.31
51998	Blank Fence Post - 5"x5"x9'	53.01	58.31
57050	Fairfield/Fairhaven (5' Tall) - 5"x5"x78" - End Post	44.37	48.81
57051	Fairfield/Fairhaven (5' Tall) - 5"x5"x78" - Line Post	44.37	48.81
57052	Fairfield/Fairhaven (5' Tall) - 5"x5"x78" - Corner Post	44.37	48.81
51994	Blank Fence Post - 5"x5"x78"	44.37	48.81
ITEM #	6' FAIRHAVEN - FENCE SECTIONS & GATES	WHITE	ALMOND
20190	Fairhaven - 6'x8' - Semi-Privacy Fence (2" Picket Spacing)	311.63	342.79
34122	Fairhaven Gate - 6'x4' Semi-Privacy (2" Spacing)	368.36	405.20
34123	Fairhaven Gate - 6'x5' Semi-Privacy (2" Spacing)	414.87	456.36
ITEM #	6' FAIRHAVEN - POSTS	WHITE	ALMOND
57054	Fairfield/Fairhaven (6' Tall) - 5"x5"x9' - End Post	53.01	58.31
57055	Fairfield/Fairhaven (6' Tall) - 5"x5"x9' - Line Post	53.01	58.31
57056	Fairfield/Fairhaven (6' Tall) - 5"x5"x9' - Corner Post	53.01	58.31
51998	Blank Fence Post - 5"x5"x9'	53.01	58.31
57057	Fairfield/Fairhaven (6' Tall) - 5"x5"x78" - End Post	44.37	48.81
57058	Fairfield/Fairhaven (6' Tall) - 5"x5"x78" - Line Post	44.37	48.81
57059	Fairfield/Fairhaven (6' Tall) - 5"x5"x78" - Corner Post	44.37	48.81
51994	Blank Fence Post - 5"x5"x78"	44.37	48.81

**FAIRHAVEN**  
**5'X8', 6'X8' SEMI-PRIVACY FENCE**

ITEM #		ACCESSORIES	WHITE	ALMOND
31016	5" Pyramid Cap		4.84	5.32
31146	5" Classic New England Cap		13.04	15.00
31148	5" New England Cap		16.31	17.94
31030	5" Gothic (Spade) Cap		23.22	22.70
35603	6' Tall Gate Brace		27.73	33.27
ITEM #		HARDWARE	BLACK	ALMOND
39887	5"x5"x96" Gate Post Insert		135.39	-
35380	Keystone 1-Sided External Mount Nylon Latch		41.16	-
35382	Keystone 2-Sided External Mount Nylon Latch		68.28	-
35320	Heavy Duty Self-Close Hinge Pair		97.84	-
35405	Stainless Steel Drop Rod - 24"		65.83	-
35411	Nationwide Gate Handle With Bumper		23.38	-
39694	1.5 oz Vinyl Adhesive		9.61	-
39697	6 oz Vinyl Adhesive		29.16	-

**\*NOTE: A minimum fence order fee of \$45 will be added to orders with 10 or less fence panels.**



**4'X8', 5'X8', 6'X8' SEMI-PRIVACY FENCE**

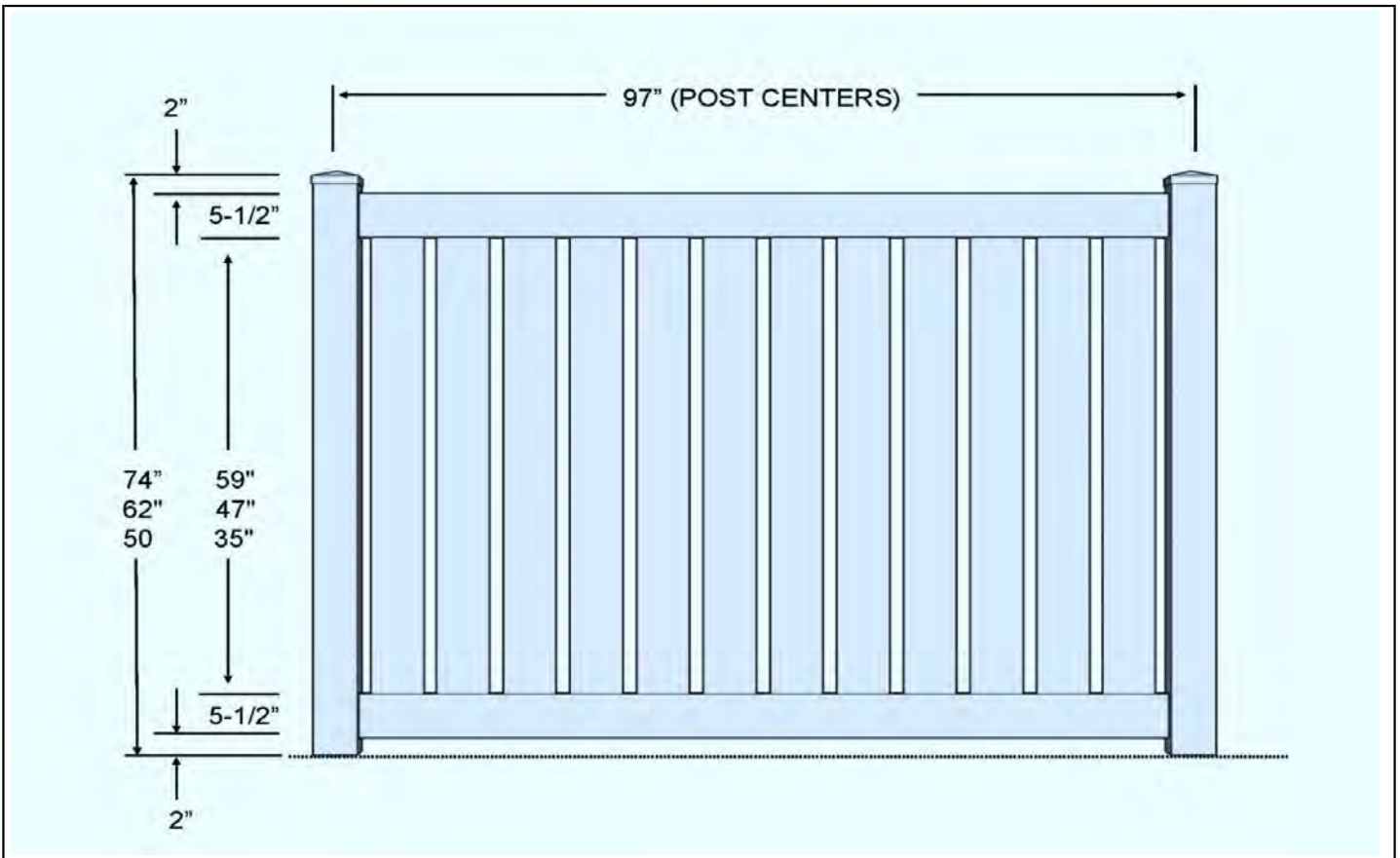

COLORS: White (W), Almond (A)

4' JACKSON - FENCE SECTIONS & GATES		WHITE*	ALMOND*
20200	Jackson - 4'x8' - Semi Privacy Fence	193.08	212.39
34133	Jackson Gate - 4'x4' Semi-Privacy	299.98	329.98
34134	Jackson Gate - 4'x5' Semi-Privacy	346.94	381.63
4' JACKSON - POSTS		WHITE	ALMOND
57100	4' Privacy/4' Jackson Semi-Privacy - 5"x5"x78" - End Post	44.37	48.81
57101	4' Privacy/4' Jackson Semi-Privacy - 5"x5"x78" - Line Post	44.37	48.81
57102	4' Privacy/4' Jackson Semi-Privacy - 5"x5"x78" - Corner Post	44.37	48.81
51994	Blank Fence Post - 5"x5"x78"	44.37	48.81
57110	4' Privacy/4' Jackson Semi-Privacy - 5"x5"x5' - End Post	35.38	38.92
57111	4' Privacy/4' Jackson Semi-Privacy - 5"x5"x5' - Line Post	35.38	38.92
57112	4' Privacy/4' Jackson Semi-Privacy - 5"x5"x5' - Corner Post	35.38	38.92
51990	Blank Fence Post - 5"x5"x5'	35.38	38.92
5' JACKSON - FENCE SECTIONS & GATES		WHITE	ALMOND
20202	Jackson - 5'x8' - Semi Privacy Fence	264.26	290.69
34135	Jackson Gate - 5'x4' Semi-Privacy	368.62	405.48
34136	Jackson Gate - 5'x5' Semi-Privacy	438.68	482.55
5' JACKSON - POSTS		WHITE	ALMOND
57120	5' Privacy/5' Jackson Semi-Privacy - 5"x5"x9' - End Post	53.01	58.31
57121	5' Privacy/5' Jackson Semi-Privacy - 5"x5"x9' - Line Post	53.01	58.31
57122	5' Privacy/5' Jackson Semi-Privacy - 5"x5"x9' - Corner Post	53.01	58.31
51998	Blank Fence Post - 5"x5"x9'	53.01	58.31
57130	5' Privacy/5' Jackson Semi-Privacy - 5"x5"x78" - End Post	44.37	48.81
57131	5' Privacy/5' Jackson Semi-Privacy - 5"x5"x78" - Line Post	44.37	48.81
57132	5' Privacy/5' Jackson Semi-Privacy - 5"x5"x78" - Corner Post	44.37	48.81
51994	Blank Fence Post - 5"x5"x78"	44.37	48.81

**4'X8', 5'X8', 6'X8' SEMI-PRIVACY FENCE**

<b>6' JACKSON - FENCE SECTIONS &amp; GATES</b>		<b>WHITE</b>	<b>ALMOND</b>
20204	Jackson - 6'x8' - Semi Privacy Fence	264.26	290.69
34137	Jackson Gate - 6'x4' Semi-Privacy	368.62	405.48
34138	Jackson Gate - 6'x5' Semi-Privacy	438.68	482.55
<b>6' JACKSON - POSTS</b>		<b>WHITE</b>	<b>ALMOND</b>
57140	6' Privacy/6' Jackson Semi-Privacy - 5"x5"x9' - End Post	53.01	58.31
57141	6' Privacy/6' Jackson Semi-Privacy - 5"x5"x9' - Line Post	53.01	58.31
57142	6' Privacy/6' Jackson Semi-Privacy - 5"x5"x9' - Corner Post	53.01	58.31
51998	Blank Fence Post - 5"x5"x9'	53.01	58.31
57150	6' Privacy/6' Jackson Semi-Privacy - 5"x5"x78" - End Post	44.37	48.81
57151	6' Privacy/6' Jackson Semi-Privacy - 5"x5"x78" - Line Post	44.37	48.81
57152	6' Privacy/6' Jackson Semi-Privacy - 5"x5"x78" - Corner Post	44.37	48.81
51994	Blank Fence Post - 5"x5"x78"	44.37	48.81
<b>ACCESSORIES</b>		<b>WHITE</b>	<b>ALMOND</b>
31016	5" Pyramid Cap	4.84	5.32
31146	5" Classic New England Cap	13.04	15.00
31148	5" New England Cap	16.31	17.94
31030	5" Gothic (Spade) Cap	23.22	22.70
35600	4' Tall Gate Brace	23.97	28.75
35603	6' Tall Gate Brace	27.73	33.27
<b>HARDWARE</b>		<b>BLACK</b>	<b>ALMOND</b>
39887	5"x5"x96" Gate Post Insert	135.39	-
35380	Keystone 1-Sided External Mount Nylon Latch	41.16	-
35382	Keystone 2-Sided External Mount Nylon Latch	68.28	-
35315	Nationwide Self-Close Adjustable Hinge Pair (4' Tall Gates)	78.06	-
35320	Heavy Duty Self-Close Hinge Pair	97.84	-
35405	Stainless Steel Drop Rod - 24"	65.83	-
35411	Nationwide Gate Handle With Bumper	23.38	-
39694	1.5 oz Vinyl Adhesive	9.61	-
39697	6 oz Vinyl Adhesive	29.16	-

**\*NOTE: A minimum fence order fee of \$45 will be added to orders with 10 or less fence panels.**

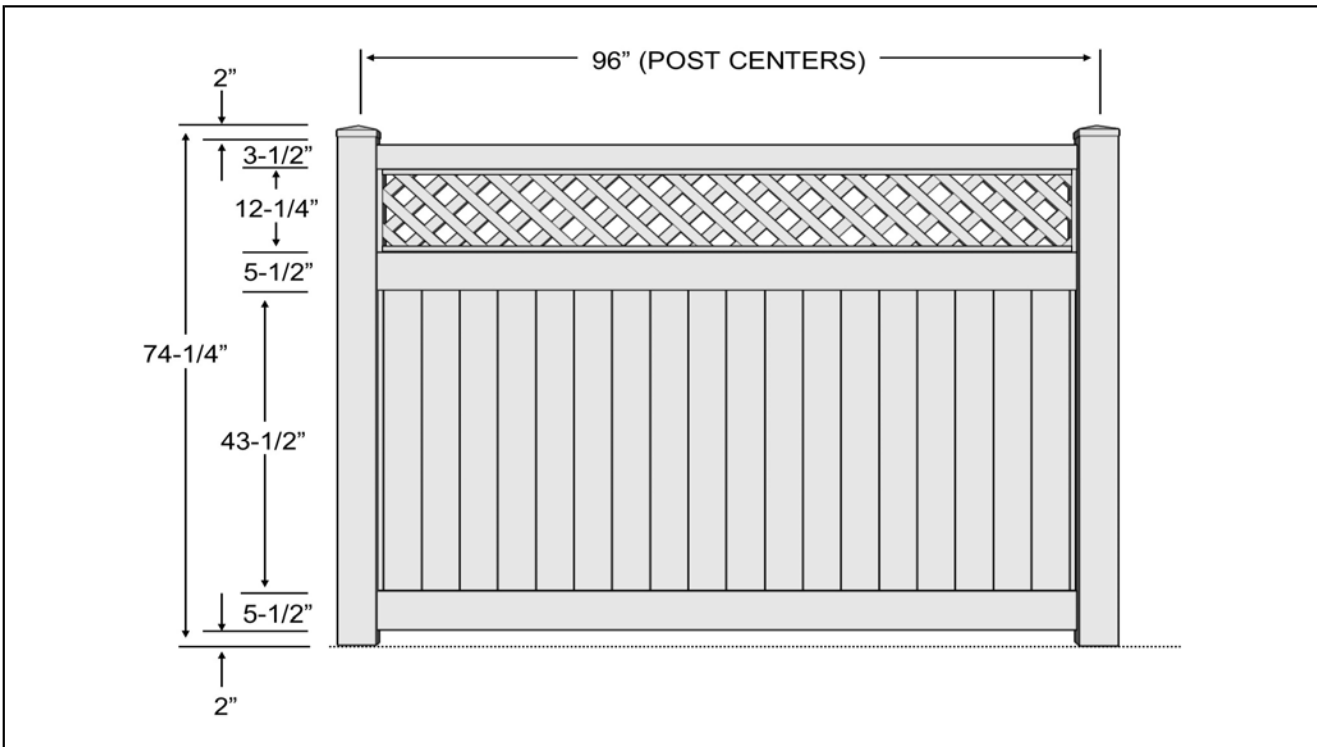

COLOR: White (W)

6' JEFFERSON PRIVACY - FENCE SECTIONS & GATES		WHITE*
20212	Jefferson Privacy Fence with Lattice Top - 6'x8'	355.66
34160	Jefferson Privacy w/ Lattice Top Gate - 6'x4'	412.86
34161	Jefferson Privacy w/ Lattice Top Gate - 6'x5'	479.60
6' JEFFERSON PRIVACY POSTS		WHITE
57080	Jefferson/Washington (6' Tall) - 5"x5"x9' - End Post	53.01
57081	Jefferson/Washington (6' Tall) - 5"x5"x9' - Line Post	53.01
57082	Jefferson/Washington (6' Tall) - 5"x5"x9' - Corner Post	53.01
51998	Blank Fence Post - 5"x5"x9'	53.01
57090	Jefferson/Washington (6' Tall) - 5"x5"x78" - End Post	44.37
57091	Jefferson/Washington (6' Tall) - 5"x5"x78" - Line Post	44.37
57092	Jefferson/Washington (6' Tall) - 5"x5"x78" - Corner Post	44.37
51994	Blank Fence Post - 5"x5"x78"	44.37
ACCESSORIES		WHITE
31016	5" Pyramid Cap	4.84
31146	5" Classic New England Cap	13.04
31148	5" New England Cap	16.31
31030	5" Gothic (Spade) Cap	23.22
35603	6' Tall Gate Brace	27.73
HARDWARE		BLACK
39887	5"x5"x96" Gate Post Insert	135.39
35380	Keystone 1-Sided External Mount Nylon Latch	41.16
35382	Keystone 2-Sided External Mount Nylon Latch	68.28
35320	Heavy Duty Self-Close Hinge Pair	97.84
35405	Stainless Steel Drop Rod - 24"	65.83
35411	Nationwide Gate Handle With Bumper	23.38
39107	#8 x 3/4" - Stainless Self-Tapping U-Channel Screw - Bag of 25	4.00
39694	1.5 oz Vinyl Adhesive	9.61
39697	6 oz Vinyl Adhesive	29.16

**\*NOTE: A minimum fence order fee of \$45 will be added to orders with 10 or less fence panels.**

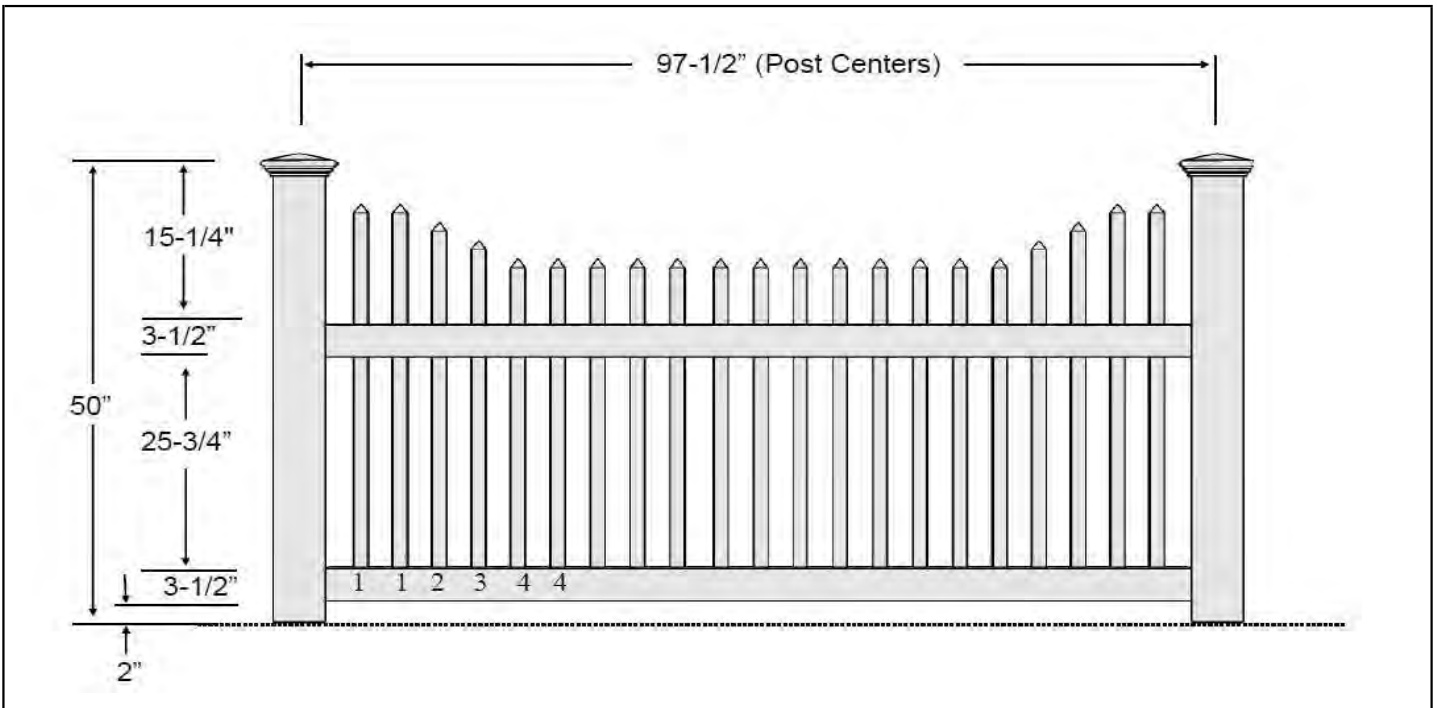

COLORS: White (W), Almond (A)

<b>4' NEW ENGLAND CONCAVE PICKET - FENCE SECTIONS &amp; GATES</b>			
ITEM #		WHITE*	ALMOND*
20218	New England Concave Picket Fence - 4'x8'	389.62	428.58
34178	New England Concave Picket - Gate 4'x4'	425.19	467.71
34179	New England Concave Picket - Gate 4'x5'	467.71	514.49
<b>4' NEW ENGLAND CONCAVE PICKET POSTS</b>			
ITEM #		WHITE	ALMOND
57020	Columbia (Charleston)/ New England Concave - 5"x5"x78" End Post	44.37	48.81
57021	Columbia (Charleston)/ New England Concave - 5"x5"x78" Line Post	44.37	48.81
57022	Columbia (Charleston)/ New England Concave - 5"x5"x78" Corner Post	44.37	48.81
51994	Blank Fence Post - 5"x5"x78"	44.37	48.81
57030	Columbia (Charleston)/ New England Concave - 5"x5"x5' End Post	35.38	38.92
57031	Columbia (Charleston)/ New England Concave - 5"x5"x5' Line Post	35.38	38.92
57032	Columbia (Charleston)/ New England Concave - 5"x5"x5' Corner Post	35.38	38.92
51990	Blank Fence Post - 5"x5"x5'	35.38	38.92
<b>ACCESSORIES</b>			
ITEM #		WHITE	ALMOND
31016	5" Pyramid Cap	4.84	5.32
31146	5" Classic New England Cap	13.04	15.00
31148	5" New England Cap	16.31	17.94
31030	5" Gothic (Spade) Cap	23.22	22.70
35600	4' Tall Gate Brace	23.97	28.75
35603	6' Tall Gate Brace	27.73	33.27
<b>HARDWARE</b>			
ITEM #		BLACK	ALMOND
39887	5"x5"x96" Gate Post Insert	135.39	-
35380	Keystone 1-Sided External Mount Nylon Latch	41.16	-
35382	Keystone 2-Sided External Mount Nylon Latch	68.28	-
35315	Nationwide Self-Close Adjustable Hinge Pair (4' Tall Gates)	78.06	-
35405	Stainless Steel Drop Rod - 24"	65.83	-
39694	1.5 oz Vinyl Adhesive	9.61	-
39697	6 oz Vinyl Adhesive	29.16	-

**\*NOTE: A minimum fence order fee of \$45 will be added to orders with 10 or less fence panels.**

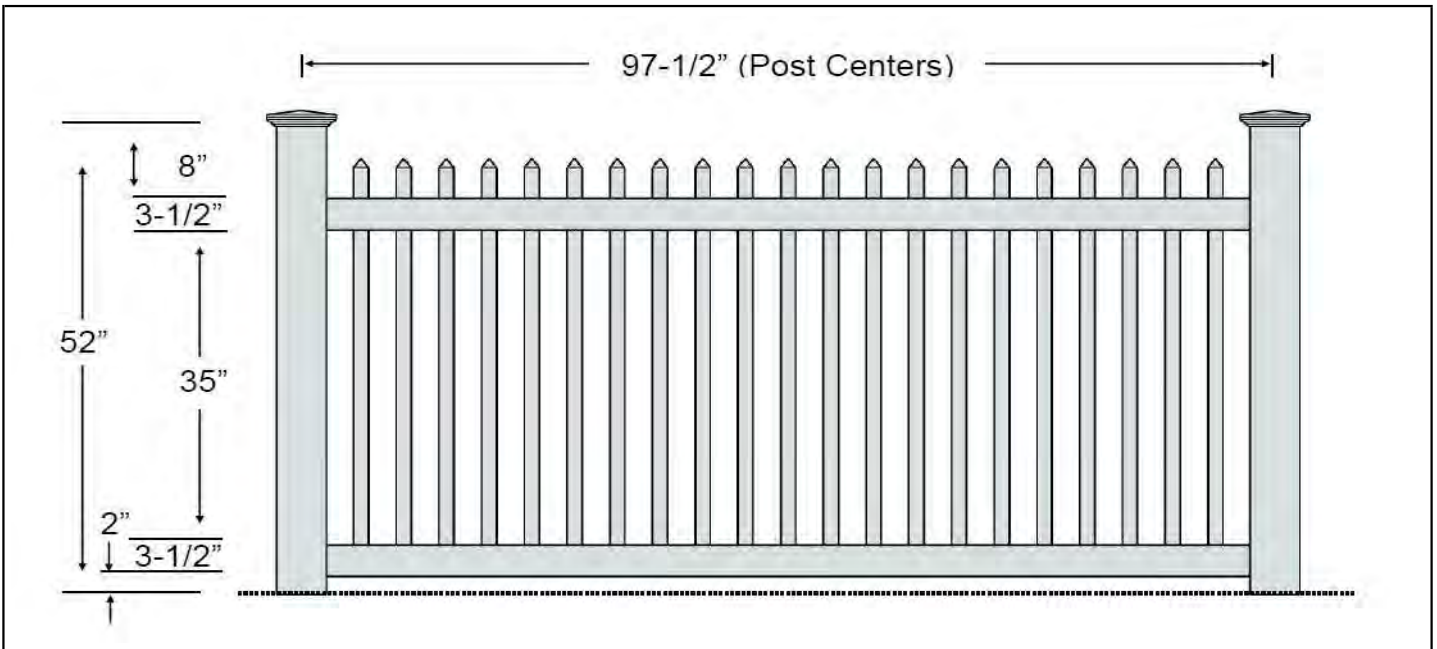

COLORS: White (W), Almond (A)

4' NEW ENGLAND STRAIGHT PICKET - FENCE SECTIONS & GATES		WHITE*	ALMOND*
ITEM #			
20215	New England Straight Picket Fence - 4'x8'	354.19	389.62
34170	New England Straight Picket - Gate - 4'x4'	354.19	389.62
34171	New England Straight Picket - Gate - 4'x5'	467.71	514.49
4' NEW ENGLAND STRAIGHT PICKET POSTS		WHITE	ALMOND
ITEM #			
56258	New England Straight Picket - 5"x5"x78" - End Post	44.37	48.81
59259	New England Straight Picket - 5"x5"x78" - Line Post	44.37	48.81
56260	New England Straight Picket - 5"x5"x78" - Corner Post	44.37	48.81
51994	Blank Fence Post - 5"x5"x78"	44.37	48.81
56248	New England Straight Picket - 5"x5"x5' - End Post	35.38	38.92
56249	New England Straight Picket - 5"x5"x5' - Line Post	35.38	38.92
56250	New England Straight Picket - 5"x5"x5' - Corner Post	35.38	38.92
51990	Blank Fence Post - 5"x5"x5'	35.38	38.92
ACCESSORIES		WHITE	ALMOND
ITEM #			
31016	5" Pyramid Cap	4.84	5.32
31146	5" Classic New England Cap	13.04	15.00
31148	5" New England Cap	16.31	17.94
31030	5" Gothic (Spade) Cap	23.22	22.70
35600	4' Tall Gate Brace	23.97	28.75
35603	6' Tall Gate Brace	27.73	33.27
HARDWARE		BLACK	ALMOND
ITEM #			
39887	5"x5"x96" Gate Post Insert	135.39	-
35380	Keystone 1-Sided External Mount Nylon Latch	41.16	-
35382	Keystone 2-Sided External Mount Nylon Latch	68.28	-
35315	Nationwide Self-Close Adjustable Hinge Pair (4' Tall Gates)	78.06	-
35405	Stainless Steel Drop Rod - 24"	65.83	-
39694	1.5 oz Vinyl Adhesive	9.61	-
39697	6 oz Vinyl Adhesive	29.16	-

**\*NOTE: A minimum fence order fee of \$45 will be added to orders with 10 or less fence panels.**

# RANCH RAIL 2, 3, 4 RAIL FENCE

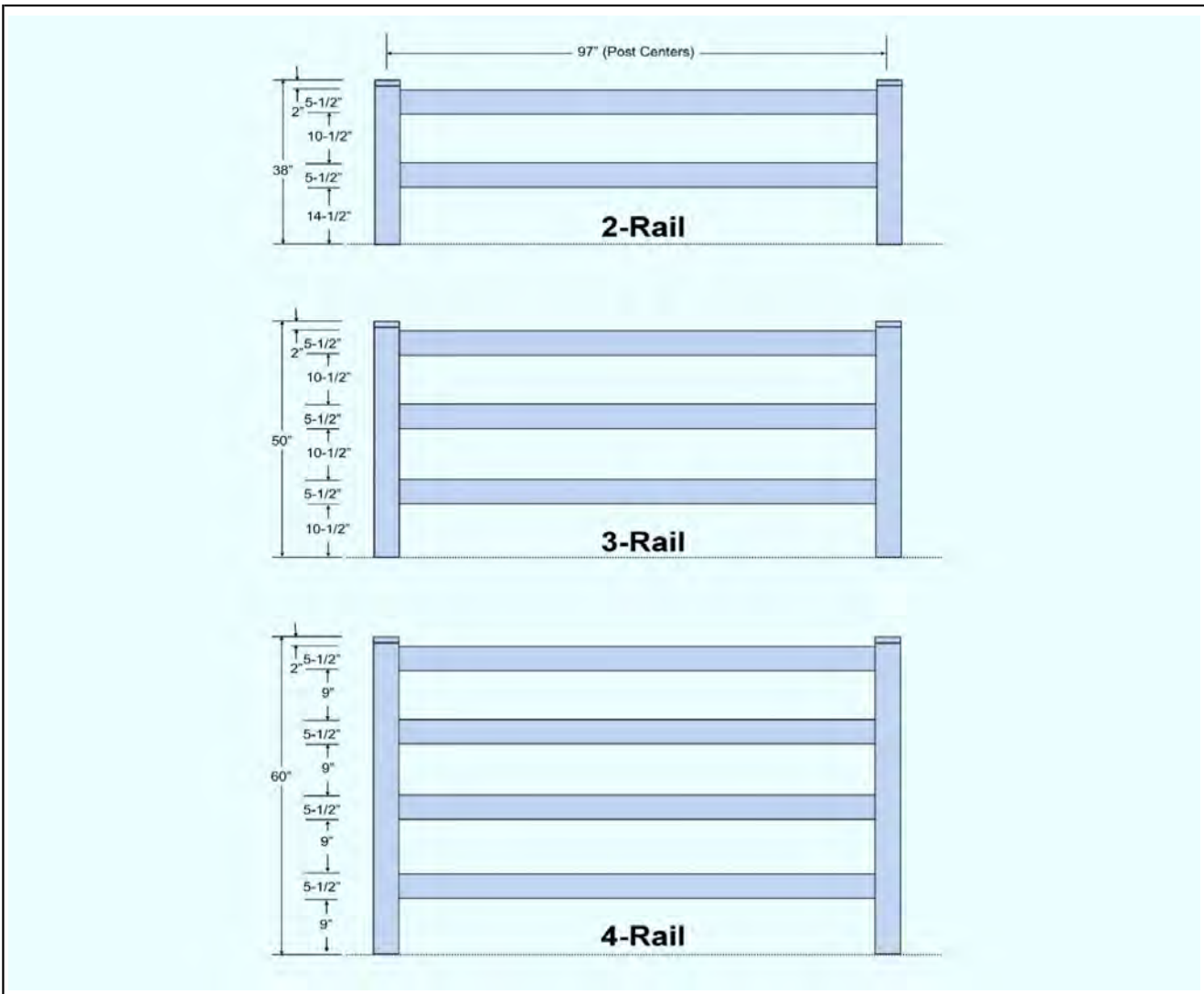

COLORS: White (W)

ITEM #	RAILS	WHITE*
60147	Ranch Rail - 1½" x 5½" x 95" - Ribbed - No Notch	23.89
60155	Ranch Rails - 1½ x 5½ x 16' - Notched - CUSTOMER PICK-UP ONLY	47.72
ITEM #	2 RAIL RANCH RAIL POSTS	WHITE
56276	Ranch - 5"x5"x78" - 2-Rail End Post	44.37
56277	Ranch - 5"x5"x78" - 2-Rail Line Post	44.37
56278	Ranch - 5"x5"x78" - 2-Rail Corner Post	44.37
51994	Blank Fence Post - 5"x5"x78"	44.37
56279	Ranch - 5"x5"x5' - 2-Rail End Post	35.38
56280	Ranch - 5"x5"x5' - 2-Rail Line Post	35.38
56281	Ranch - 5"x5"x5' - 2-Rail Corner Post	35.38
51990	Blank Fence Post - 5"x5"x5'	35.38
ITEM #	3 RAIL RANCH RAIL POSTS	WHITE
56282	Ranch - 5"x5"x78" - 3-Rail End Post	44.37
56283	Ranch - 5"x5"x78" - 3-Rail Line Post	44.37
56284	Ranch - 5"x5"x78" - 3-Rail Corner Post	44.37
51994	Blank Fence Post - 5"x5"x78"	44.37
56285	Ranch - 5"x5"x5' - 3-Rail End Post	35.38
56286	Ranch - 5"x5"x5' - 3-Rail Line Post	35.38
56287	Ranch - 5"x5"x5' - 3-Rail Corner Post	35.38
51990	Blank Fence Post - 5"x5"x5'	35.38

# RANCH RAIL 2, 3, 4 RAIL FENCE

ITEM #	4 RAIL RANCH RAIL POSTS	WHITE
56288	Ranch - 5"x5"x9' - 4-Rail End Post	53.01
56289	Ranch - 5"x5"x9' - 4-Rail Line Post	53.01
56290	Ranch - 5"x5"x9' - 4-Rail Corner Post	53.01
51998	Blank Fence Post - 5"x5"x9'	53.01
56291	Ranch - 5"x5"x78" - 4-Rail End Post	44.37
56292	Ranch - 5"x5"x78" - 4-Rail Line Post	44.37
56293	Ranch - 5"x5"x78" - 4-Rail Corner Post	44.37
51994	Blank Fence Post - 5"x5"x78"	44.37
ITEM #	POST CAPS	WHITE
31016	5" Pyramid Cap	4.84
31146	5" Classic New England Cap	13.04
31148	5" New England Cap	16.31
31030	5" Gothic (Spade) Cap	23.22
ITEM #	GATES & HARDWARE	WHITE
35520	2 Rail Ranch Gate Posts - Pair	206.78
35522	3 Rail Ranch Gate Posts - Pair	206.78
35524	4 Rail Ranch Gate Posts - Pair	219.74
35550	3 Rail Ranch Gate Brace	49.29
35555	4 Rail Ranch Gate Brace	65.76
39887	5"x5"x96" Gate Post Insert	135.39
35380	Keystone 1-Sided External Mount Nylon Latch	41.16
35382	Keystone 2-Sided External Mount Nylon Latch	68.28
35320	Heavy Duty Self-Close Hinge Pair	97.84
35405	Stainless Steel Drop Rod - 24"	65.83
39694	1.5 oz Vinyl Adhesive	9.61
39697	6 oz Vinyl Adhesive	29.16

**\*NOTE: A minimum fence order fee of \$45 will be added to orders with 10 or less fence panels.**

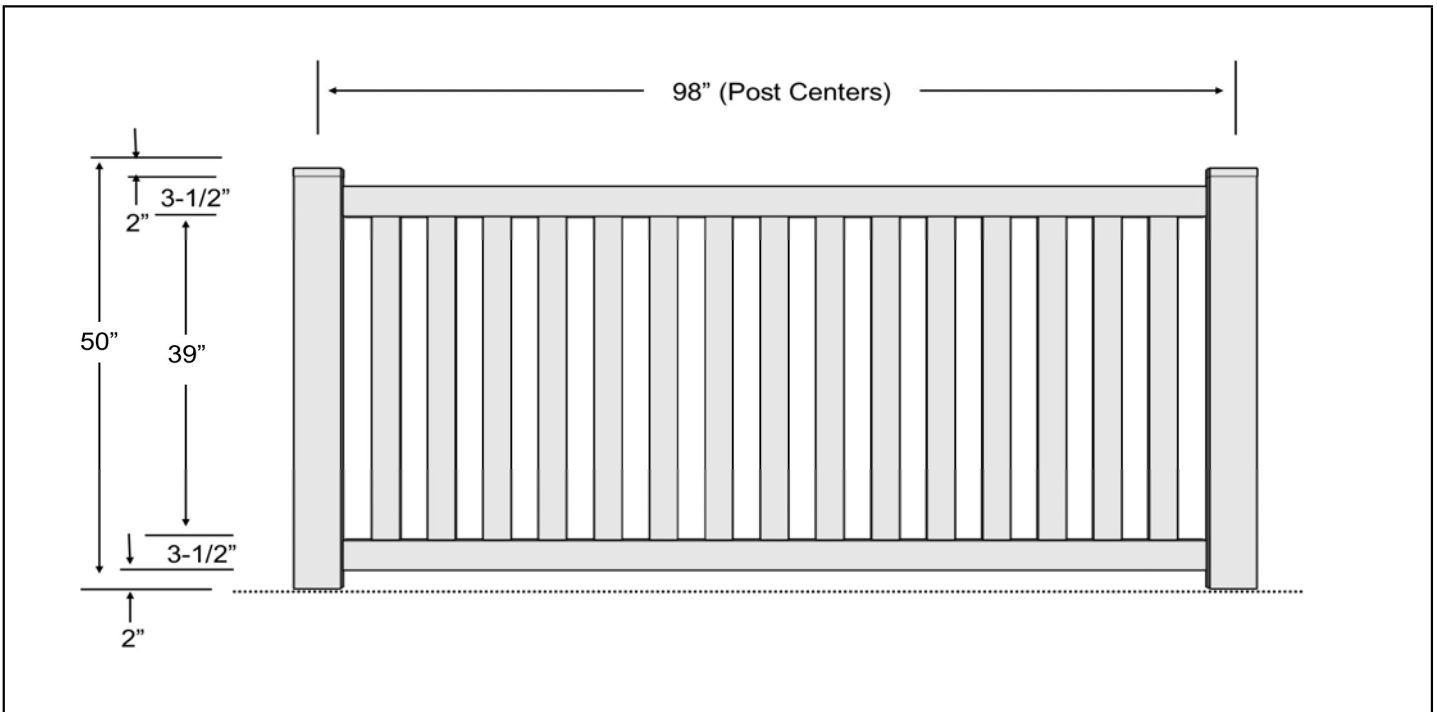

COLORS: White (W), Almond (A)

4' STRATFORD PICKET - FENCE SECTIONS & GATES		WHITE*	ALMOND*
20278	Stratford - 4'x8' Picket Fence (2" Picket Space)	231.83	255.01
34208	Stratford Gate - 4'x4' Picket (2" Spacing)	306.34	336.97
34209	Stratford Gate - 4'x5' Picket (2" Spacing)	344.48	378.93
4' STRATFORD PICKET POSTS		WHITE	ALMOND
57060	Stratford/Victorian (4' Tall) - 5"x5"x78" - End Post	44.37	48.81
57061	Stratford/Victorian (4' Tall) - 5"x5"x78" - Line Post	44.37	48.81
57062	Stratford/Victorian (4' Tall) - 5"x5"x78" - Corner Post	44.37	48.81
51994	Blank Fence Post - 5"x5"x78"	44.37	48.81
57070	Stratford/Victorian (4' Tall) - 5"x5"x5' - End Post	35.38	38.92
57071	Stratford/Victorian (4' Tall) - 5"x5"x5' - Line Post	35.38	38.92
57072	Stratford/Victorian (4' Tall) - 5"x5"x5' - Corner Post	35.38	38.92
51990	Blank Fence Post - 5"x5"x5'	35.38	38.92
ACCESSORIES		WHITE	ALMOND
31016	5" Pyramid Cap	4.84	5.32
31146	5" Classic New England Cap	13.04	15.00
31148	5" New England Cap	16.31	17.94
31030	5" Gothic (Spade) Cap	23.22	22.70
35600	4' Tall Gate Brace	23.97	28.75
35603	6' Tall Gate Brace	27.73	33.27
HARDWARE		BLACK	ALMOND
39887	5"x5"x96" Gate Post Insert	135.39	-
35380	Keystone 1-Sided External Mount Nylon Latch	41.16	-
35382	Keystone 2-Sided External Mount Nylon Latch	68.28	-
35315	Nationwide Self-Close Adjustable Hinge Pair (4' Tall Gates)	78.06	-
35405	Stainless Steel Drop Rod - 24"	65.83	-
39694	1.5 oz Vinyl Adhesive	9.61	-
39697	6 oz Vinyl Adhesive	29.16	-

**\*NOTE: A minimum fence order fee of \$45 will be added to orders with 10 or less fence panels.**



**4'X8', 5'X8', 6'X8' PRIVACY FENCE**

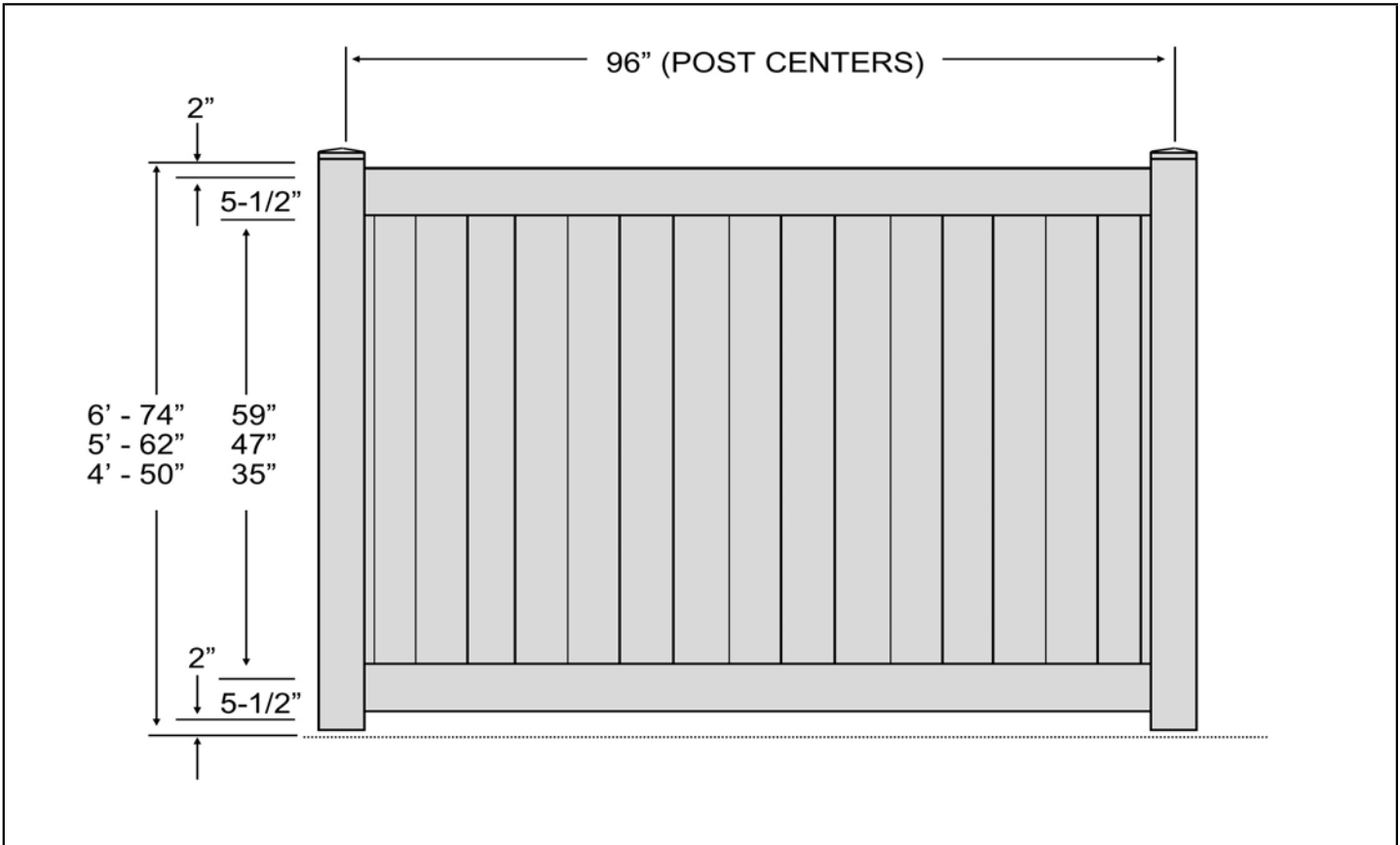

COLORS: White (W), Almond (A), Coastal Cedar (CC), Dark Walnut (DW)

4' TRADITIONS PRIVACY- FENCE SECTIONS & GATES		W*	A*	CC*	DW*
20220	Traditions Privacy Fence Panel - 4'x8'	203.88	224.27	-	-
34180	Traditions Privacy Gate - 4'x4'	324.60	357.06	-	-
34181	Traditions Privacy Gate - 4'x5'	375.83	413.41	-	-
4' TRADITIONS PRIVACY- POSTS		W	A	CC	DW
57100	4' Privacy/4' Jackson Semi-Privacy - 5"x5"x78" - End Post	44.37	48.81	-	-
57101	4' Privacy/4' Jackson Semi-Privacy - 5"x5"x78" - Line Post	44.37	48.81	-	-
57102	4' Privacy/4' Jackson Semi-Privacy - 5"x5"x78" - Corner Post	44.37	48.81	-	-
51994	Blank Fence Post - 5"x5"x78"	44.37	48.81	-	-
57110	4' Privacy/4' Jackson Semi-Privacy - 5"x5"x5' - End Post	35.38	38.92	-	-
57111	4' Privacy/4' Jackson Semi-Privacy - 5"x5"x5' - Line Post	35.38	38.92	-	-
57112	4' Privacy/4' Jackson Semi-Privacy - 5"x5"x5' - Corner Post	35.38	38.92	-	-
51990	Blank Fence Post - 5"x5"x5'	35.38	38.92	-	-
5' TRADITIONS PRIVACY- FENCE SECTIONS & GATES		W	A	CC	DW
20221	Traditions Privacy Fence Panel - 5'x8'	246.91	271.60	-	-
34182	Traditions Privacy Gate - 5'x4'	359.46	395.41	-	-
34183	Traditions Privacy Gate - 5'x5'	404.52	444.97	-	-
5' TRADITIONS PRIVACY- POSTS		W	A	CC	DW
57120	5' Privacy/5' Jackson Semi-Privacy - 5"x5"x9' - End Post	53.01	58.31	-	-
57121	5' Privacy/5' Jackson Semi-Privacy - 5"x5"x9' - Line Post	53.01	58.31	-	-
57122	5' Privacy/5' Jackson Semi-Privacy - 5"x5"x9' - Corner Post	53.01	58.31	-	-
51998	Blank Fence Post - 5"x5"x9'	53.01	58.31	-	-
57130	5' Privacy/5' Jackson Semi-Privacy - 5"x5"x78" - End Post	44.37	48.81	-	-
57131	5' Privacy/5' Jackson Semi-Privacy - 5"x5"x78" - Line Post	44.37	48.81	-	-
57132	5' Privacy/5' Jackson Semi-Privacy - 5"x5"x78" - Corner Post	44.37	48.81	-	-
51994	Blank Fence Post - 5"x5"x78"	44.37	48.81	-	-

**4'X8', 5'X8', 6'X8' PRIVACY FENCE**

ITEM #		6' TRADITIONS PRIVACY- FENCE SECTIONS & GATES	W	A	CC	DW
20222		Traditions Privacy Fence Panel - 6'x8'	251.71	276.88	359.27	529.22
34184		Traditions Privacy Gate - 6'x4'	373.71	411.08	510.57	644.65
34185		Traditions Privacy Gate - 6'x5'	430.48	473.53	583.91	740.90
ITEM #		6' TRADITIONS PRIVACY- POSTS	W	A	CC	DW
57140		6' Privacy/6' Jackson Semi-Privacy - 5"x5"x9' - End Post	53.01	58.31	80.87	149.56
57141		6' Privacy/6' Jackson Semi-Privacy - 5"x5"x9' - Line Post	53.01	58.31	80.87	149.56
57142		6' Privacy/6' Jackson Semi-Privacy - 5"x5"x9' - Corner Post	53.01	58.31	80.87	149.56
51998		Blank Fence Post - 5"x5"x9'	53.01	58.31	80.87	149.56
57150		6' Privacy/6' Jackson Semi-Privacy - 5"x5"x78" - End Post	44.37	48.81	60.08	95.45
57151		6' Privacy/6' Jackson Semi-Privacy - 5"x5"x78" - Line Post	44.37	48.81	60.08	95.45
57152		6' Privacy/6' Jackson Semi-Privacy - 5"x5"x78" - Corner Post	44.37	48.81	60.08	95.45
51994		Blank Fence Post - 5"x5"x78"	44.37	48.81	60.08	95.45
ITEM #		ACCESSORIES	W	A	CC	DW
31016		5" Pyramid Cap	4.84	5.32	6.87	7.36
31146		5" Classic New England Cap	13.04	15.00	-	-
31148		5" New England Cap	16.31	17.94	25.74	35.09
31030		5" Gothic (Spade) Cap	23.22	22.70	-	-
35600		4' Tall Gate Brace	23.97	28.75	-	-
35603		6' Tall Gate Brace	27.73	33.27	-	-
ITEM #		HARDWARE	BLACK	A	CC	DW
39887		5"x5"x96" Gate Post Insert	135.39	-	-	-
35380		Keystone 1-Sided External Mount Nylon Latch	41.16	-	-	-
35382		Keystone 2-Sided External Mount Nylon Latch	68.28	-	-	-
35315		Nationwide Self-Close Adjustable Hinge Pair (4' Tall Gates)	78.06	-	-	-
35320		Heavy Duty Self-Close Hinge Pair	97.84	-	-	-
35405		Stainless Steel Drop Rod - 24"	65.83	-	-	-
35411		Nationwide Gate Handle With Bumper	23.38	-	-	-
39107		#8 x 3/4" - Stainless Self-Tapping U-Channel Screw - Bag of 25	4.00	-	-	-
39694		1.5 oz Vinyl Adhesive	9.61	-	-	-
39697		6 oz Vinyl Adhesive	29.16	-	-	-

**\*NOTE: A minimum fence order fee of \$45 will be added to orders with 10 or less fence panels.**

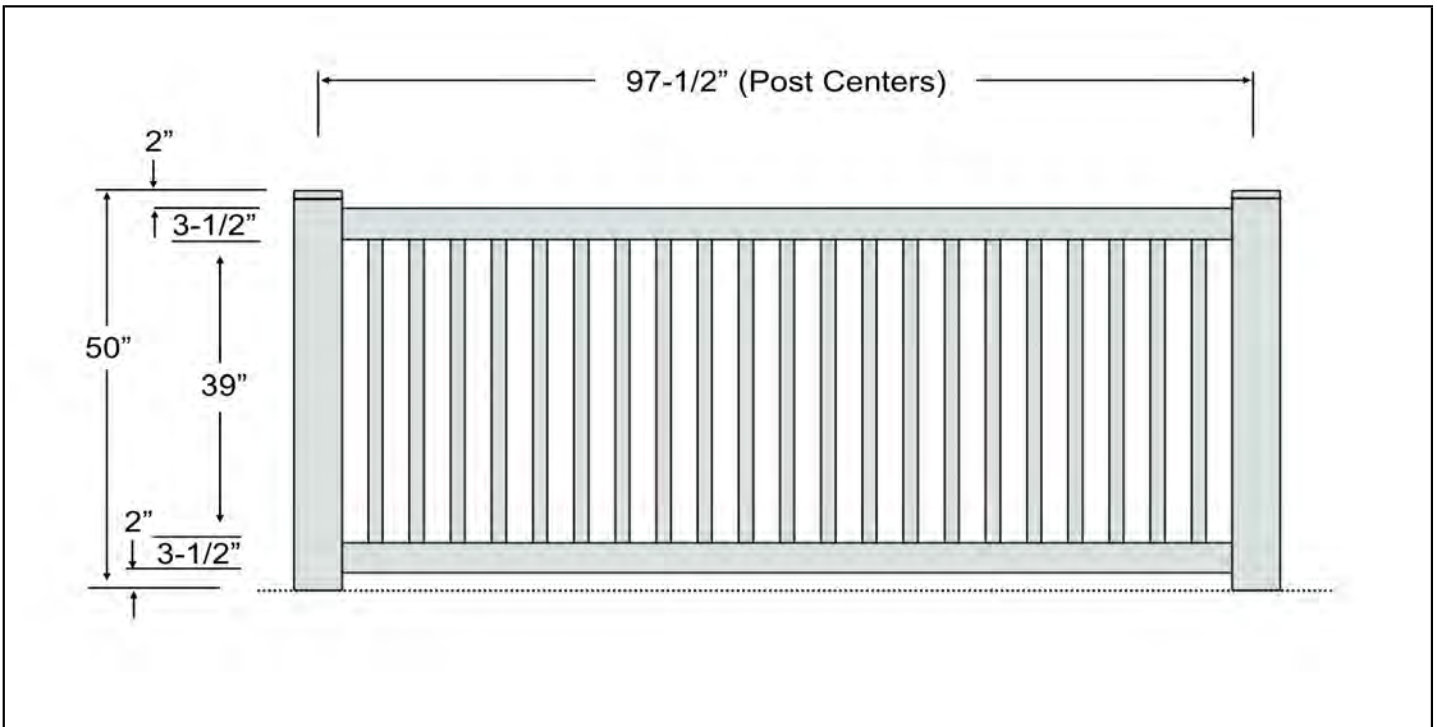

COLORS: White (W), Almond (A)

4' VICTORIAN PICKET - FENCE SECTIONS & GATES		WHITE*	ALMOND*
20299	Victorian - 4'x8' - Picket Fence	201.07	221.18
35050	Victorian Picket Gate - 4'x4'	282.05	310.26
35051	Victorian Picket Gate - 4'x5'	321.91	354.10
4' VICTORIAN PICKET POSTS		WHITE	ALMOND
57060	Stratford/Victorian (4' Tall) - 5"x5"x78" - End Post	44.37	48.81
57061	Stratford/Victorian (4' Tall) - 5"x5"x78" - Line Post	44.37	48.81
57062	Stratford/Victorian (4' Tall) - 5"x5"x78" - Corner Post	44.37	48.81
51994	Blank Fence Post - 5"x5"x78"	44.37	48.81
57070	Stratford/Victorian (4' Tall) - 5"x5"x5' - End Post	35.38	38.92
57071	Stratford/Victorian (4' Tall) - 5"x5"x5' - Line Post	35.38	38.92
57072	Stratford/Victorian (4' Tall) - 5"x5"x5' - Corner Post	35.38	38.92
51990	Blank Fence Post - 5"x5"x5'	35.38	38.92
ACCESSORIES		WHITE	ALMOND
31016	5" Pyramid Cap	4.84	5.32
31146	5" Classic New England Cap	13.04	15.00
31148	5" New England Cap	16.31	17.94
31030	5" Gothic (Spade) Cap	23.22	22.70
35600	4' Tall Gate Brace	23.97	28.75
35603	6' Tall Gate Brace	27.73	33.27
HARDWARE		BLACK	ALMOND
39887	5"x5"x96" Gate Post Insert	135.39	-
35380	Keystone 1-Sided External Mount Nylon Latch	41.16	-
35382	Keystone 2-Sided External Mount Nylon Latch	68.28	-
35315	Nationwide Self-Close Adjustable Hinge Pair (4' Tall Gates)	78.06	-
35405	Stainless Steel Drop Rod - 24"	65.83	-
39694	1.5 oz Vinyl Adhesive	9.61	-
39697	6 oz Vinyl Adhesive	29.16	-

**\*NOTE: A minimum fence order fee of \$45 will be added to orders with 10 or less fence panels.**

# WASHINGTON 6'X8' PRIVACY FENCE

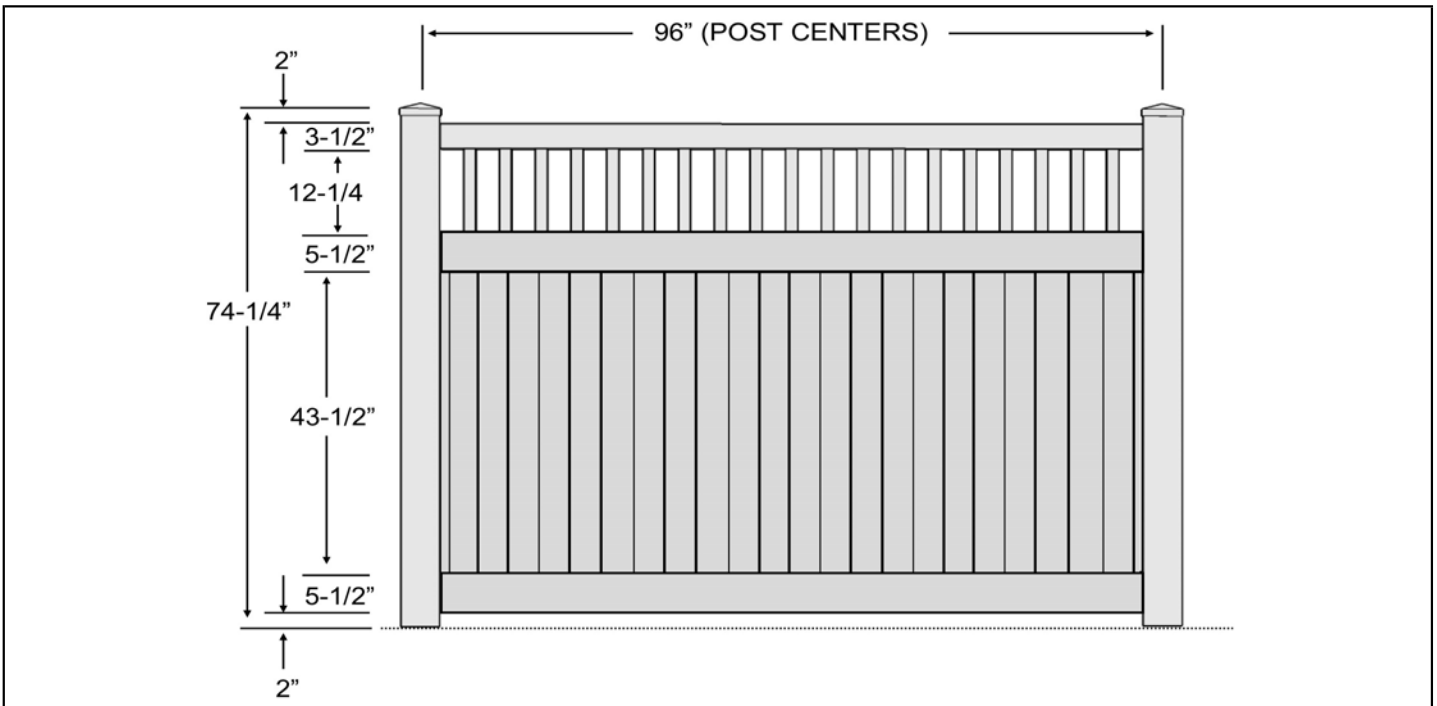

COLORS: White (W), Almond (A)

6' WASHINGTON PRIVACY - FENCE SECTIONS & GATES		WHITE*	ALMOND*
ITEM #			
20290	Washington - 6'x8' - Privacy Fence with Picket Top	387.48	426.23
34220	Washington Gate - 6'x4' Picket Top Privacy	387.76	426.54
34221	Washington Gate - 6'x5' Picket Top Privacy	454.50	499.95
6' WASHINGTON PRIVACY POSTS		WHITE	ALMOND
ITEM #			
57080	Jefferson/Washington (6' Tall) - 5"x5"x9' - End Post	53.01	58.31
57081	Jefferson/Washington (6' Tall) - 5"x5"x9' - Line Post	53.01	58.31
57082	Jefferson/Washington (6' Tall) - 5"x5"x9' - Corner Post	53.01	58.31
51998	Blank Fence Post - 5"x5"x9'	53.01	58.31
57090	Jefferson/Washington (6' Tall) - 5"x5"x78" - End Post	44.37	48.81
57091	Jefferson/Washington (6' Tall) - 5"x5"x78" - Line Post	44.37	48.81
57092	Jefferson/Washington (6' Tall) - 5"x5"x78" - Corner Post	44.37	48.81
51994	Blank Fence Post - 5"x5"x78"	44.37	48.81
ACCESSORIES		WHITE	ALMOND
ITEM #			
31016	5" Pyramid Cap	4.84	5.32
31146	5" Classic New England Cap	13.04	15.00
31148	5" New England Cap	16.31	17.94
31030	5" Gothic (Spade) Cap	23.22	22.70
35603	6' Tall Gate Brace	27.73	33.27
HARDWARE		BLACK	ALMOND
ITEM #			
39887	5"x5"x96" Gate Post Insert	135.39	-
35380	Keystone 1-Sided External Mount Nylon Latch	41.16	-
35382	Keystone 2-Sided External Mount Nylon Latch	68.28	-
35320	Heavy Duty Self-Close Hinge Pair	97.84	-
35405	Stainless Steel Drop Rod - 24"	65.83	-
35411	Nationwide Gate Handle With Bumper	23.38	-
39107	#8 x 3/4" - Stainless Self-Tapping U-Channel Screw - Bag of 25	4.00	-
39694	1.5 oz Vinyl Adhesive	9.61	-
39697	6 oz Vinyl Adhesive	29.16	-

**\*NOTE: A minimum fence order fee of \$45 will be added to orders with 10 or less fence panels.**